

**Amica**

Inteligentny styl

**OPERATING  
INSTRUCTIONS  
EN**

IO-WMS-0976  
(01.2018/1)

**AHD8WH**



ONLY USE THE APPLIANCE WHEN YOU HAVE  
READ AND UNDERSTAND THE OPERATING  
INSTRUCTIONS

**DRYER**

# CONTENTS

ECOLOGY IN PRACTICE	3
BASIC INFORMATION	5
SAFETY AND GERMENT CARE LABELS	6
INSTALL THE APPLIANCE	15
PRODUCT DESCRIPTION	15
MAINTENANCE AND CLEANING	25
TROUBLESHOOTING	29
SPECIFICATIONS	31
PRODUCT FICHE	32



In accordance with European Directive **2012/19/EU** and Polish legislation regarding used electrical and electronic goods, this appliance is marked with the symbol of the crossed-out waste container.

This marking indicates that the appliance must not be disposed of together with other household waste after it has been used. The user is obliged to hand it over to waste collection centre collecting used electrical and electronic goods. The collectors, including local collection points, shops and local authority departments provide recycling schemes. Proper handling of used electrical and electronic goods helps avoid environmental and health hazards resulting from the presence of dangerous components and the inappropriate storage and processing of such goods.

## ECOLOGY IN PRACTICE

For many years, Amica has consistently pursued pro-ecological policy. Concern for the environment is as important for us as the use of modern technology. That's why we focus on energy-efficient appliances of the highest energy efficiency class – A+, A++ and A+++.

The development of technology has enabled our factories to become more environmentally friendly - we use less and less water, electricity and less waste water and solid waste is generated in the production.

A lot of attention is paid to materials used in production. We strive to use only those that do not contain harmful substances and make recycling and safe disposal possible after use.

# Dear customer!

Thank you for choosing an Amica product. For years we have delivered high-quality appliances, so that household chores become a real pleasure. Before being packaged and leaving the manufacturer, the appliance was thoroughly checked with regard to safety and functionality. We also endeavour to make sure that modern technology in Amica products always goes hand in hand with a unique design.

Before using the appliance, please carefully read these Operating Instructions. Follow these instructions to avoid improper use and ensure long and reliable operation of the appliance. Learn the principles of the safe use to avoid accidents.

Store these operating instructions in a safe place to use them for reference whenever needed. These Operating Instructions contain all the necessary information that will make the use of your Amica appliance simple and fun. We also encourage you to find out more about other Amica appliances.

We hope using your new appliance is a pleasure.

**Amica**

# BASIC INFORMATION



This dryer is intended for household use only for drying textiles and clothing.

Before plugging the appliance into the mains, remove the safety packaging and ensure the appliance is level. The manufacturer reserves the right to introduce changes, which do not affect operation of the appliance.

## USAGE

- Carefully read the instructions below before using the appliance.
- Never use the appliance outdoors or anywhere the temperature may fall below freezing.
- The appliance should not be operated by children or anyone who has not read the instructions.



Temperatures below 0°C can damage the appliance! In the event of the appliance being stored or transported in sub-zero temperatures, it should be left to acclimatise in a temperature above 0°C for 8 hours before being used.

## MANUFACTURER'S DECLARATION

The manufacturer hereby declares that this product meets the requirements of the following European directives:

- Low Voltage Directive, **2014/35/EU**,
- Electromagnetic Compatibility (EMC) Directive **2014/30/EE**,

and has been marked with the CE symbol and issued with a declaration of compliance made available to market regulators.

	<p>This appliance should not be used by children under 8 years of age, persons with reduced physical or mental capabilities, and persons who do not have sufficient skills to use this type of appliance. Such persons should be offered proper supervision or instructions on safe handling of appliance and related risks. Children must not play with the appliance or perform any maintenance-related activities. Children under 3 years of age must be kept away from the appliance unless continuously supervised.</p>
	<p>Children could get caught inside the appliance and get into a life-threatening situation.</p>
	<p>This product belongs to Category I electrical appliances, and only for drying textiles which have been washed with water in the household. Please pay attention to the safety of power use during the operation!</p>
	<p>The power source with reliable earthing must be used. Its earth wire must be buried under the ground and shall not be connected with the public utilities such as city water pipe or gas pipe etc. The earth wire and null wire shall be distinguished and shall not be connected together.</p>

## SAFETY AND GERMENT CARE LABELS

	Do not put more load than recommended. Obey the maximum load volume. Please check and refer to Drying Programmes Table in the user manual.
	That the tumble dryer is not to be used if industrial chemicals have been used for cleaning.
	Do not dry unwashed items in the tumble dryer.
	Items that have been soiled with substances such as cooking oil, acetone, alcohol, petrol, kerosene, spot removers, turpentine, waxes and wax removers should be washed in hot water with an extra amount of detergent before being dried in the tumble dryer.
	Items such as foam rubber (latex foam), shower caps, waterproof textiles, rubber backed articles and clothes or pillows fitted with foam rubber pads should not be dried in the tumble dryer.

## SAFETY AND GERMENT CARE LABELS

	Fabric softeners, or similar products, should be used as specified by the fabric softener instructions.
	The final part of a tumble dryer cycle occurs without heat (cool down cycle) to ensure that the items are left at a temperature that ensures that the items will not be damaged.
	The lint trap has to be cleaned frequently.
	The lint must not to be allowed to accumulate around the tumble dryer.
	Adequate ventilation has to be provided to avoid the back flow of gases into the room from appliance burning other fuels, including open fires.
	The exhaust air must not be discharged into a flue which is used for exhausting fumes from appliance burning gas or other fuels.
	The appliance must not be install behind a lockable door, a sliding door or a door with a hinge on the opposite side to that of the tumble dryer. In such a way that a full opening of the tumble dryer door is restricted.



## SAFETY AND GERMENT CARE LABELS

	<p>Oil-affected items can ignite spontaneously, especially when exposed to heat sources such as in a tumble dryer. The items become warm, causing an oxidation reaction in the oil. Oxidation creates heat. If the heat cannot escape, the items can become hot enough to catch fire. Piling, stacking or storing oil-affected items can prevent heat from escaping and so create a fire hazard.</p>
	<p>If it is unavoidable that fabrics that contain vegetable or cooking oil or have been contaminated by hair care products be placed in a tumble dryer they should first be washed in hot water with extra detergent-this will reduce, but not eliminate, the hazard.</p>
	<p>The appliance should not be overturned during normal use or maintenance.</p>

## SAFETY AND GERMENT CARE LABELS

	Remove all objects from pockets such as lighters and matches.
	If the power cable is damaged, it must be replaced by the manufacturer, its service agent or similarly qualified persons in order to avoid a hazard.
	This appliance is for indoor use only.
	The openings must not be obstructed by a carpet.
	If the appliance appears high temperature abnormally, please draw the mail plug immediately.
	The appliance is not intended for use by persons (including children) with reduced physical, sensory or mental capabilities, or lack of experience and knowledge, unless they have been given supervision or instruction concerning use of the appliance by a person responsible for their safety. Children should be supervised to ensure that they do not play with the appliance. (This warning is not for EUROPEAN market).

## SAFETY AND GERMENT CARE LABELS

<p>Important!</p>	<p>Never stop a tumble dryer before the end of the drying cycle otherwise too much heat will diffuse and may cause harm.</p>
	<p>The appliance is secured for transport with transit bolts. If you don't remove transit bolts before using the appliance, the appliance may be damaged. Remove all transit bolts before using the appliance for the first time. Make sure you keep transit bolts in a safe place for future use. If the appliance will be transported, to avoid any damage, you must reinstall the transit bolts.</p>
<p>Electric shock hazard</p>	<p>Do not pull the power cord forcefully. Please disconnect the mains plug instead.</p> <p>Please do not plug/draw the mains plug with wet hands.</p> <p>Do not damage the power cord and the power plug.</p>













<p>Injury danger</p>	<p>Do not disassemble or install the dryer without any instruction or supervision.</p> <p>Do not stack this dryer on washing machine without stacking kits. (if you want to stack this dryer on washing machine, please purchase the independent parts and it must be installed by the manufacturer, its service agent or similarly qualified persons to avoid any hazards.).</p> <p>Do not lean on the opened door of the dryer.</p> <p>Do not put any pyrotoxin on the dryer, such as the candle, electric cooker.</p>
<p>Damage danger</p>	<p>Do not dry over the rated capacity.</p> <p>Do not operate the dryer without the filter door and filter base.</p> <p>Do not dry the clothes before being spun.</p> <p>Do not expose the dryer directly under the sun, indoor use only.</p> <p>Do not install the dryer in humid and drenching environment.</p>

## SAFETY AND GERMENT CARE LABELS

Damage danger	While cleaning and maintenance, please do remember to pull out the power plug and do not directly wash the dryer with water.
Explosion danger	Please do not dry the clothes with any flammable substances such as coal oil or alcohol. Otherwise, there may be explosion.

## UNDERSTANDING THE SYMBOLS ON CLOTHES LABELS

Before drying pay attention to the symbols on the apparel label.  
 Failure to follow the symbol instructions may damage or destroy clothes to be dried.  
 The symbols are explained in the following table:

Dry 	Normal 	Do not tumble dry 	Do not dry 
Line dry/hang to dry 	Drip dry 	Dry flat 	Dry in the shade 
Dry clean 	Do not dry clean 	Dry clean normal cycle with any solvent 	Dry clean normal cycle petroleum solvent only 



# INSTALL THE APPLIANCE

1

## Product Description

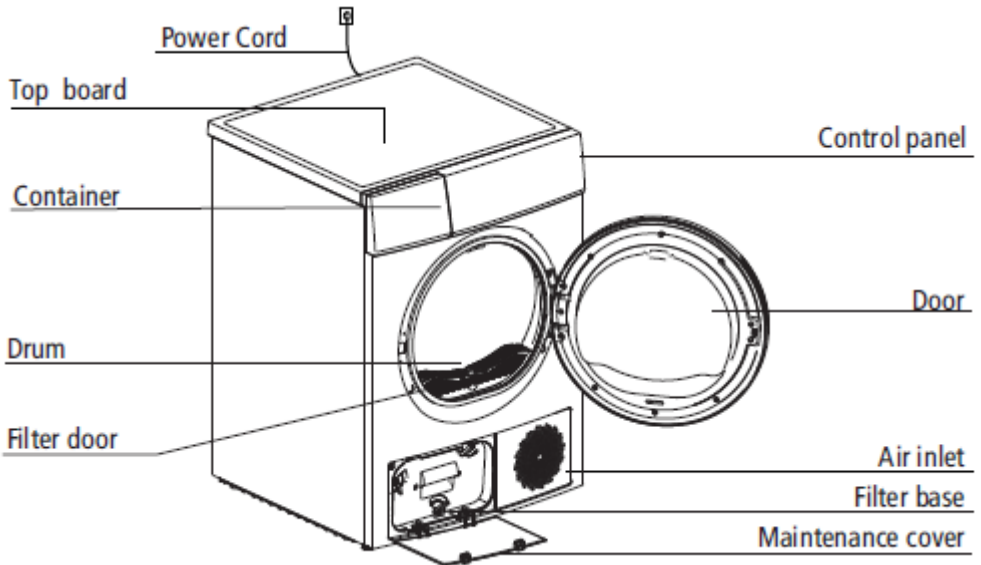

Please see the products you purchased in kind prevail.

2

## Accessories

- The following parts are optional for specific models.

If your dryer has following parts, please wear gloves and install them as per the instruction below.

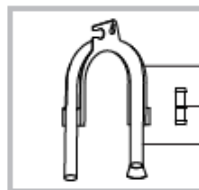

Hose holder

Connector

Condensing drain hose

## Installation

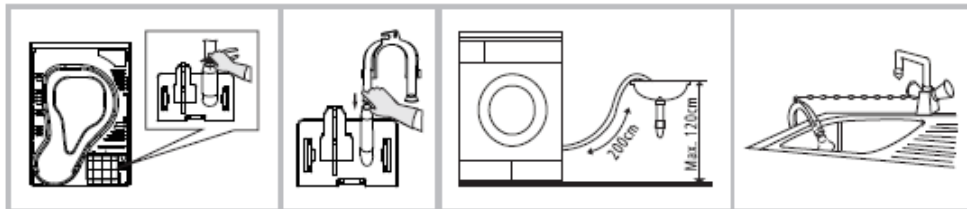

Use pliers to remove the drain hose from the hose connector.

Insert the external drainage hose.

Put the hose holder on the washing basin or any other sink.



Remove the drain hose from the housing drawer.

Insert the drain hose and the external drainage hose into the connector.

Put the hose holder on the washing basin or any other sink.

## Transport

- Move cautiously. Do not grasp any salient parts of machine. The machine door can not be used as the handle for delivery. If the dryer can't be transported erectly, the dryer could be slant to right less than 30°.

## Installation Position

- It is recommended that, for your convenience, the machine is positioned close to your washing machine.
- The tumble dryer must be installed in a clean place, where dirt does not build up. Air must be able to circulate freely all round the appliance. Do not obstruct the front air inlet or the air intake grilles at the back of the machine.
- To keep vibration and noise within minimum level when the dryer is in use, it should be placed on a firm and level surface.
- The feet must never be removed. Do not restrict the floor clearance through deep pile carpets, strips of wood or similar. This might cause heat built-up which would interfere with the operation of the appliance.



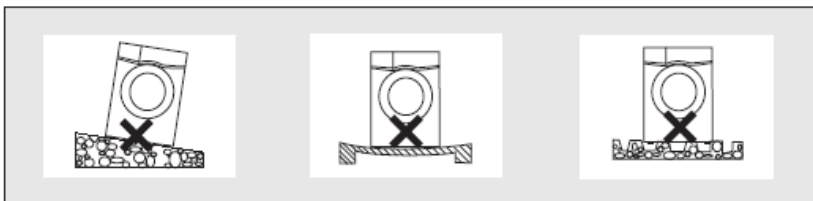

6

### Level Adjusting

- Once in its permanent operating position, check that the dryer is absolutely level with the aid of a spirit level. If it is not, adjust the feet with a tool.

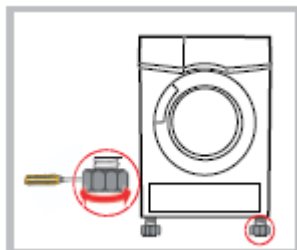

- Make sure that the voltage of the power supply is the same as the electric specification of the dryer.
- Do not connect the dryer with the power connection board, the universal plug or socket, do not use multi-plug adapters and extension cables.

7

### Quick Start



Before using, please make sure it's installed properly !

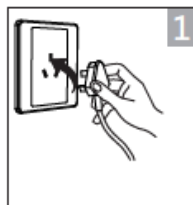

plug in

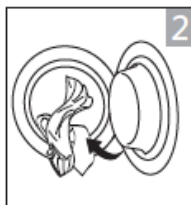

load

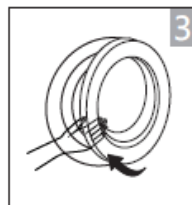

close door

### Drying



on



select program



select function  
or default



start

**After Drying**

- Buzzer beep or "0:00" on display.

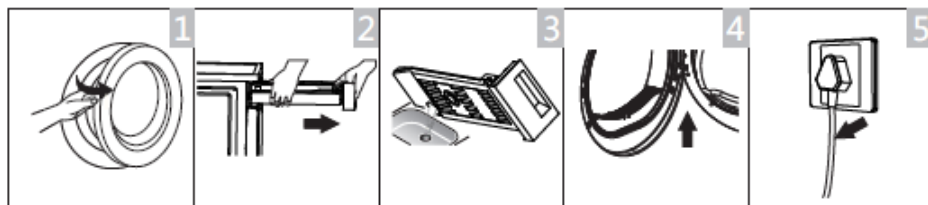

open the door and  
take out laundry

pull out the  
container

pour out  
condensate water

clean the filter

power off



If the socket with a switch is used, please press the switch to turn off the power directly!

**Before Each Drying**

Leave it to stand for 2 hours after transporting. Before first use, please use the soft fabric to clean the inside drum.

Put some clean rags into the drum.

Plug the power, press .

Select the [Refresh] programme, press  button.

After finishing this programme, please follow the "cleaning and care" to clean the filter door.

During drying, the compressor and the water will generate some noise which is entirely normal.

## Before Each Drying

Before drying, thoroughly spin the laundry in washing machine. High spin speed can the drying time and save energy consumption.

For uniform drying result, sort the laundry according to fabric type and drying programme.

Before drying, please close zips, hooks and eyelets, button up, tie fabric belts, etc.

Do not over dry the clothes, because over dried clothes can easily get creases.

Do not dry the articles containing rubber or similar elastic materials.











The door can be opened only after the programme of the drying machine finishes to from being scalded by hot steam or over heated drying machine.

Clean the lint filter and empty container after each use to avoid extension of drying time and energy consumption.

Do not dry these clothes after dry-clean process.

Please choose the related programme when dealing with wool material clothes, to make the cloth more fresh and fluffy.

The reference weight of dry clothes (each)

Mixed-fabric clothes (about 800 g) 	Jacket (about 800g cotton) 	Jeans (about 800 g) 	Towel quilt (about 900g cotton) 
Single beds heet (about 600g cotton) 	Work clothes (about 1120g) 	Sleep wear (about 200g) 	Long sleeve shirt (about 300g cotton) 
Short sleeve shirt (about 180g cotton) 	Short pants (about 70g cotton) 	Socks (about 50g mixed-weave) 	



Never overload !

Not for textile with dropping water. The dryer could be damaged, even fire !

## DISPLAY AND CONTROL PANEL

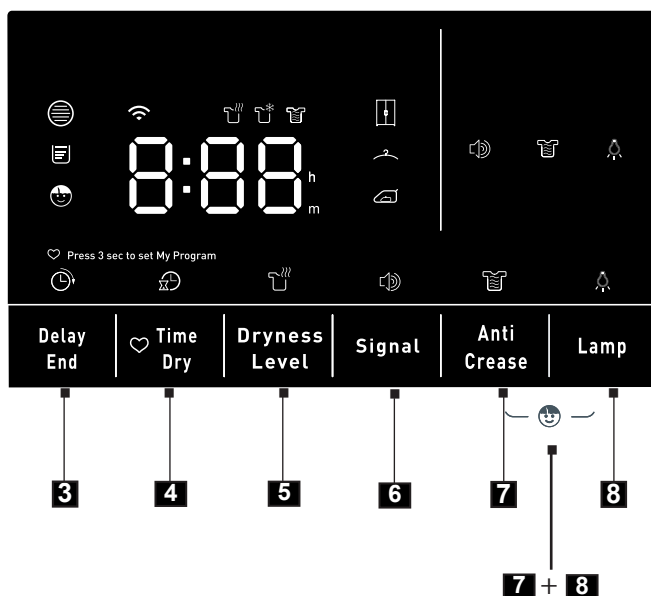
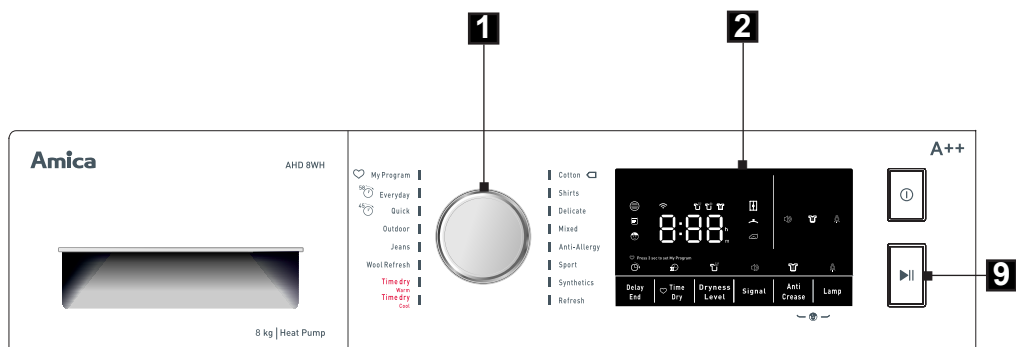



1. Programme selector dial
2. Display
3. Delay
4. Time Dry
5. Dryness Level
6. Signal
7. Anti Crease
8. Lamp
9. Start/Pause
- 7+8 Child Lock

## DISPLAY AND CONTROL PANEL

















1

### Programmes selector dial

- Press the  button. When the LED display screen brightens up, rotate the programme knob to select the desired programme.
- Select the [Delay End], [Time dry], [Dryness level], [Signal], [Anti-Crease] or [Lamp] functions for additional options.
- Press the  button.

2

### Display





	Filter Please clean the filter when the signal is lighting, after the dryer stops
	Tank Please empty the container when the "" is lighting, after the dryer stops.
	Delay start
	Time
	Child lock
	Remaining Time indicator/Error message
	Cycle phase status
	Clean filters (warning)
	Empty water container (warning)
	Dryness level: Extra
	Dryness level: Standard
	Dryness level: Iron
	Drum lamp indicator
	Signal indicator
	Anti-crease mode
	My cycle

3

### Delay End

- This function is used for delaying clothes drying time within 24 hours. The delay time means the programme will finish after x hours.

Steps in details:

- Load your laundry and make sure the machine door is closed.
- Press the  button, then to turn the programme selector knob and select a desired programme.
- You can select the [Signal] functions according to your need
- Press the [Delay End] button.
- Continue to press the [Delay End] to select the delay time.
- After the  button is pressed, the Dryer is at the running condition.
- The drying procedure will be finished when the delay time is over.
- If you press the  button again, the delay function will be paused.
- If you want to cancel the [Delay End] function, please press the  button.

4

### Time Dry

When the warm or cool or refresh programme is selected, the [Time] button can be used to adjust the drying time in 10 min. steps.

5

### Dryness Level

Use for adjusting the dryness level of the laundry.

- The Dryness level function can be activated only before the programme starts.
- Press the [Dryness level] button repeatedly to select the drying time.
- Except the [Cotton] [Mixed] [Jean] [Synthetics] [Outdoor], all the other programmes can not be set with the [Dryness level] function.

6

### Signal

Set the buzzer on or off. In general condition, the buzzer is off. Please touch it if needed.

When the buzzer is on:

- The dryer will make the leading sound if press the extra function buttons.
- If the programme knob is rotated when the dryer is running, the dryer will remind the operator that it is an invalid programme selection.
- When the drying programme is done, the buzzer will beep to remind the user.

## DISPLAY AND CONTROL PANEL

7

### Anti-Crease

- At the end of the drying cycle, the anti-crease phase time is 30 minutes (default) or 120 minutes (selected).
- This function prevents the laundry from creases. The laundry can be removed during the anti-crease phase. Except [Time cool], [Time warm] and [Refresh], all the other programmes have this function.

8

### Lamp

The lamp inside the drum will be on for lighting about 3 minutes when the button is pressed or 1 minute when the door is open.

### My Cycle

Used to define and save your favorite programmes that are used frequently.

1. Use the programme knob to select the required programme and other drying functions.
  2. Press and hold the [Time dry] button for 3 seconds until the beep and the required programme has been saved.
  3. Turn the programme selector to the [My Cycle] position, then you can start your favorite programmes.
- If you want to change the [My Cycle] settings, repeat the steps (1) and (2).

7+8

### Child Lock

This machine incorporates a special child safety lock, which can prevent children from carelessly pressing buttons or making the faulty operation.

When the dryer is at the operation status, press the [Anti-Crease] and [Steam] buttons at the same time for over 3 seconds to start child lock function. When child lock function is set, the display will show Child lock icon and no key can have an effect on the dryer except  button.

To activate the child lock function, the [Anti-Crease] and [Steam] buttons shall be pressed at the same time for over 3 seconds.

9

### Programme start

The drum will keep rotating after the programme starts. The status light in the display area will flash in sequence, and the displayed remaining time will change automatically.

### Programme end

The drum will stop running after the programme ends. The display will show "8:88", also the status light of "End" and related light will illuminate. The dryer will start Anti-crease function if user doesn't remove the load in time.

Please press  key to cut off power and pull the plug out.

Deal with the problems according to "Malfunction display and solutions", if there is an unexpected stop during the drying procedure and the dryer shows information.





# MAINTENANCE AND CLEANING

## Cleaning and care

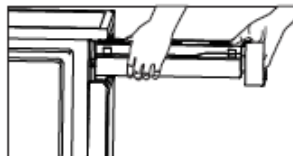
- Hold and pull out the water container with two hands.
- Tilt the water container, pour out the condensate water into basin.
- Install the water container.



Empty the water container after each use. Otherwise, the programme will be paused and the  icon will light. After the container is emptied, the dryer can be restarted by pressing  button.

Do not drink the condensate water.

Do not use the dryer without the water container.

## Clean the filters

- This dryer has a primary door fluff filter and a filter in front of the heat exchanger for added protection. Make sure you clean the filters after each cycle.

## Clean the filter door

- Open the door
- Take out the filter door
- Open the filter and remove the fluff on the filter, clean it in running water.
- Dry the filter door thoroughly before installing it back.

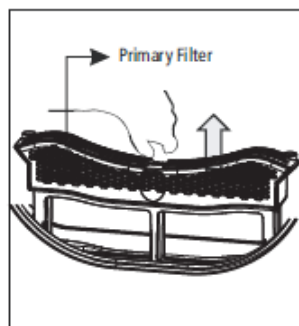

Take notice of the direction before insert the Filter Door.

## Clean heat exchanger



Do not touch the heat exchanger with your hand, which may result in causing an injury.

- As necessary, approx. once every 2 months clean the heat exchanger filter.
- Open the cover.
- Unlock three locking levers and take out the heat exchanger handle.
- Clean the rubber sealings at the handle.
- Clean the heat exchanger, remove the fluff using a vacuum cleaner with a dusting brush attached
- Re-insert the handle.
- Lock three locking levers and make sure that the levers are in right lock position.
- Close the cover until there is a click sound.

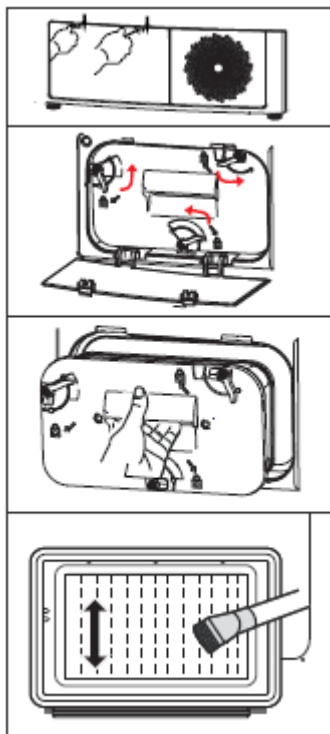

Clean the heat exchanger without applying any pressure. Otherwise the heat exchanger could be damaged.

Disconnect the power cord before cleaning!

## Clean filter base

- Open the cover.
- Unscrew both locking levers towards each other.
- Clean the filter base completely.
- Re-insert the filter base!
- Screw both locking levers.
- Close the cover until it locks into position.

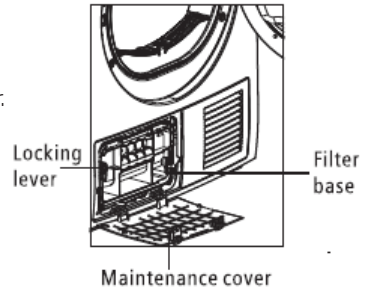

## Wash air condenser

- Leave the dryer to cool down. Residual water may escape, place an absorbent cloth under the maintenance cover.
- Unlock the maintenance cover.
  - Completely open maintenance cover.
  - Screw both locking levers towards each other.
  - Pull out the air condenser.
  - Clean the air condenser completely, drain thoroughly.
  - Clean the seals.
  - Re-insert the air condenser, handle at the button!
  - Unscrew both locking levers.
  - Close the maintenance cover until it locks into position. Please clean the air condenser approx. once every 3 months if frequently used.
  - Do not damage the air condenser!

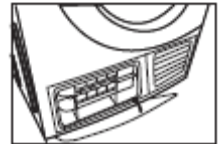
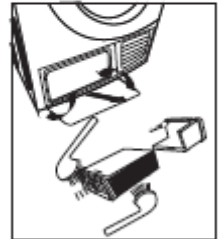
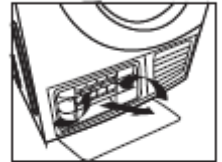
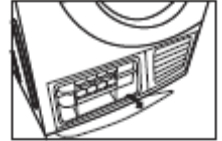

Clean with water only; do not use hard/sharp-edged objects!  
Do not operate the dryer without the air condenser!  
During drying, water may collect between the window and the seal,  
but this does not affect the function of your dryer!

## Clean Tumble dryer



Disconnect the power cord before cleaning!  
Clean the dryer with a wet cloth which is only damped by clean water. Otherwise, the chemical cleaners may damage the plastic surfaces and other parts.  
Please wear gloves when cleaning.

Prepare a wet cloth damped by clean water.  
Clean the door, especially the inside window.  
Clean the sealing around the front support.  
Clean the humidity sensor in side of the drum.  
Take out all the filters, clean the sealing and air tunnel.  
Before starting the dryer, dry all parts with a soft cloth.

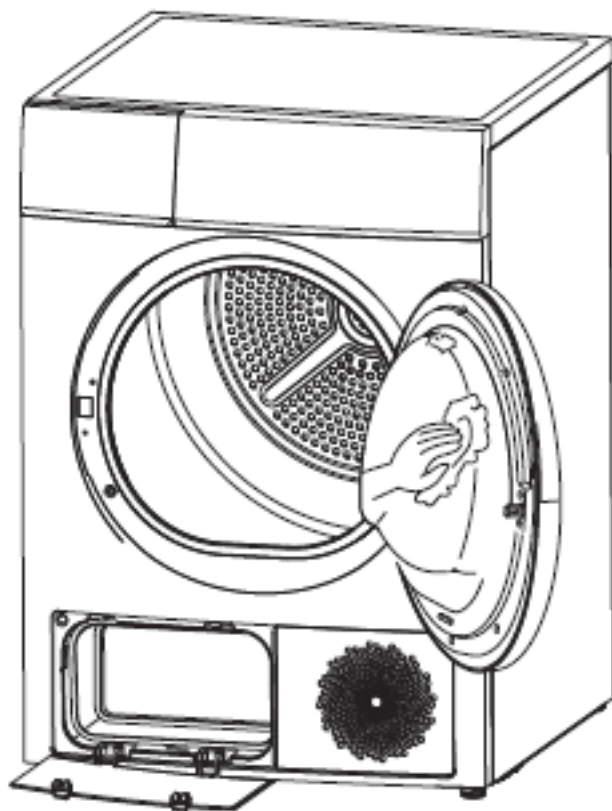

# TROUBLESHOOTING

Display	Reason	Solutions
E32	Humidity sensor error	Please contact your local service center if the problem occurs.
E33	Temperature sensor error	
E80	PCB communication error	



Only authorised technicians can carry out repairs.

Before you call service, please check if you have dealt with the problems yourself or if you have followed the user instructions.



If the LED displays other prompt and the dryer can not work, please call service. A technician will charge you for advice, even during the warranty period.

# Amica

 Service Help Line

For the UK: please call  
**01949 862012**

For Ireland: please call  
**0818 46 46 46** (non-geographic number)  
or **01 88 2010** (standard rate call)

Problem	Probable cause/Solution
Display is not on	<ul style="list-style-type: none"> <li>• Check if the power supply works.</li> <li>• Check if the mains plug is inserted.</li> <li>• Check the selected programme .</li> <li>• Press the  button.</li> </ul>
 is lighting	<ul style="list-style-type: none"> <li>• Empty water container.</li> <li>• If the light is still on, please call the service.</li> </ul>
 is lighting	<ul style="list-style-type: none"> <li>• Clean heat exchanger.</li> <li>• Clear lint filter.</li> </ul>
Dryer does not start	<ul style="list-style-type: none"> <li>• Check the door has closed.</li> <li>• Check the programme has set.</li> <li>• Check the start button has selected.</li> </ul>
Degree of dryness was not reached or drying time too long	<ul style="list-style-type: none"> <li>• Clean lint filter and heat exchanger.</li> <li>• Empty container.</li> <li>• Check drain hose.</li> <li>• Dryer installation place is too restricted.</li> <li>• Clean the moisture sensors.</li> <li>• Keep the Air inlet clean.</li> <li>• Use higher drying intensity level programme or time programme.</li> </ul>



If you cannot deal with the problems by yourself and need help:

Press the  button.

Pull out the mains plug and call the service.

# SPECIFICATION

Type	<b>AHD8WH</b>
Rated voltage	220-240V / ~50Hz
Rated power	850 W
Refrigerant	R134a
Ambient temperature*	+ 18°C ~+ 30°C
Drum capacity	max. 8 kg
Dimensions Height/Depth/Breadth	845/595/640 [mm]
Weight	48 kg
Meets the requirements of EU legislation, EN- 61121 standard	EN-61121
Contains fluorinated greenhouse gases covered by the Kyoto Protocol Hermetically sealed	

## Note:

1. Rated load is a maximum load. Always make sure that the weight of laundry in the dryer never exceeds the rated load.
2. Do not install the tumble dryer in a room where there is a risk of freezing temperature. The dryer may not work properly at temperature close to freezing.
3. Risk of damage if the condensed water freezes in the pump, hose or condensed water container.

Testing for label information in accordance with EN 61121 using the standard cotton drying programmes:

- at full load
- at partial load

I weighted average electricity consumption is **236 kWh/year**

The dryer incorporates heat pump containing fluorinated greenhouse gases covered by the Kyoto Protocol.

The gas is contained in a sealed system.

If the system is damaged, it must not be repaired, but replaced with a new one.

## Important!

Gas used in this appliance is very harmful to the ozone layer. Releasing it into the atmosphere will significantly contribute to global warming.

## Refrigerant specification:

Gas type: R-134a

Chemical formula:  $CF_3-CH_2F$

Refrigerant quantity: 0,350 kg/GWP 1430/500,5 kg eq CO<sub>2</sub>

\* The optimum ambient temperature during operation should be 18 ° C to 30 ° C. If the device is operating at a lower or higher temperature, the drying time may be prolonged or the device may not reach the target temperature.

# PRODUCT SHEET

(In accordance with Commission Delegated Regulation (EU) No. **392/2012** of 1 March 2012 supplementing Directive **2010/30/EU** of the European Parliament and of the Council with regard to energy labelling of household tumble dryers).

Supplier's name or trade mark	Amica S.A.
Type	AHD8WH
Rated load	8.0 kg
Energy efficiency class <sup>1) 2)</sup>	A++
Dryer Type	heat pump
Annual weighted average energy consumption $AE_c$ <sup>3)</sup>	236 kWh/year
Energy consumption of the standard cotton drying programme:	
- At full load $E_{dry}$	1.97 kWh
- At partial load $E_{dry1/2}$	1.08 kWh
Power consumption in the off-mode $P_o$	0.2 W
Power consumption in standby mode $P_i$	0,8 W
Duration of the left-on mode:	10 min
Condensation efficiency class on a scale from G (lowest efficiency) to A (highest efficiency) <sup>1)</sup>	B
The average condensation efficiency in the standard cotton programme at full load $C_t$	80.5%
The average condensation efficiency for the standard cotton programme at partial load $C_{dry}$	80.5%
The weighted condensation efficiency for the standard cotton programme at full and partial load $C_{dry1/2}$	80.5%
The weighted duration of the standard cotton programme at full and partial load $T_t$	127
Duration of the standard cotton programme at full load $T_{dry}$	170
Duration of the standard cotton programme at partial load $T_{dry1/2}$	95
Noise Level:	
Sound level in the standard cotton program at full load $L_{wa}$	67 dB (A) re 1 pW
Equipment designed for fitting	no
Automatic tumble dryer	no

<sup>1)</sup> Energy efficiency class on a scale from A+++ (more efficient) to D (least efficient)

<sup>2)</sup> "Standard cotton drying programme" is the programme referred to on label and in the datasheet – it is suitable for drying cotton at normal humidity levels and is the most energy efficient programme for drying cotton. This programme is suitable for drying normal, wet cotton products. It is the most energy efficient cotton drying programme.

<sup>3)</sup> Estimated weighted annual energy consumption based on 160 standard cotton drying cycles at full and partial load and power consumption in standby and off modes. Actual energy consumption depends on how the appliance is used. The dryer is equipped with a power management system. Standby time 1 minute.





# Amica

 Service Help Line

For the UK: please call  
**01949 862012**

For Ireland: please call  
**0818 46 46 46** (non-geographic number)  
or **01 88 2010** (standard rate call)