

AFC5100WH  
AFC5100SI

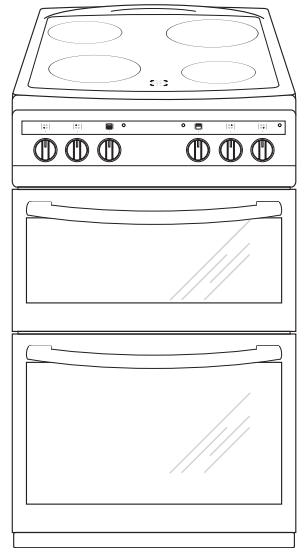

# INSTRUCTION MANUAL

ELECTRIC COOKER  
DOUBLE OVEN



IO-CFS-0515 / 8071303  
(10.2017 / v1)

## DEAR CUSTOMER,

---

*The cooker is exceptionally easy to use and extremely efficient. After reading the instruction manual, operating the cooker will be easy.*

*Before being packaged and leaving the manufacturer, the cooker was thoroughly checked with regard to safety and functionality.*

*Before using the appliance, please read the instruction manual carefully. By following these instructions carefully you will be able to avoid any problems in using the appliance.*

*It is important to keep the instruction manual and store it in a safe place so that it can be consulted at any time.*

*It is necessary to follow the instructions in the manual carefully in order to avoid possible accidents.*

### **Caution!**

*Do not use the cooker until you have read this instruction manual.*

*The cooker is intended for household use only.*

*The manufacturer reserves the right to introduce changes which do not affect the operation of the appliance.*

# TABLE OF CONTENTS

---

<b>Safety instructions</b> .....	4
<b>Description of the appliance</b> .....	9
<b>Installation</b> .....	11
<b>Operation</b> .....	13
<b>Baking in the oven – practical hints</b> .....	18
<b>Cleaning and maintenance</b> .....	20
<b>Technical data</b> .....	25

## SAFETY INSTRUCTIONS

---

**Warning:** The appliance and its accessible parts become hot during use. Care should be taken to avoid touching heating elements. Children less than 8 years of age shall be kept away unless continuously supervised.

This appliance can be used by children aged from 8 years and above and persons with reduced physical, sensory or mental capabilities or lack of experience and knowledge if they have been given supervision or instruction concerning use of the appliance in a safe way and understand the hazards involved. Children shall not play with the appliance. Cleaning and user maintenance shall not be made by children without supervision.

**Warning:** Unattended cooking on a hob with fat or oil can be dangerous and may result in fire.

NEVER try to extinguish a fire with water, but switch off the appliance and then cover flame e.g. with a lid or a fire blanket.

**Warning:** Danger of fire: do not store items on the cooking surfaces.

**Warning:** If the surface is cracked, switch off the appliance to avoid the possibility of electric shock.

During use the appliance becomes hot. Care should be taken to avoid touching heating elements inside the oven.

Accessible parts may become hot during use. Young children should be kept away.

## SAFETY INSTRUCTIONS

---

**Warning:** Do not use harsh abrasive cleaners or sharp metal scrapers to clean the oven door glass since they can scratch the surface, which may result in shattering of the glass.

**Warning:** Ensure that the appliance is switched off before replacing the lamp to avoid the possibility of electric shock.

You should not use steam cleaning devices to clean the appliance.

**Danger of burns!** Hot steam may escape when you open the oven door. Be careful when you open the oven door during or after cooking. Do NOT lean over the door when you open it. Please note that depending on the temperature the steam can be invisible.

- Always keep children away from the cooker.  
While in operation direct contact with the cooker may cause burns!
- Ensure that small items of household equipment, including connection leads, do not touch the hot oven or the hob as the insulation material of this equipment is usually not resistant to high temperatures.
- Do not leave the cooker unattended when frying. Oils and fats may catch fire due to overheating or boiling over.
- Do not allow the hob to get soiled and prevent liquids from boiling over onto the surface of the hob. This refers in particular to sugar which can react with the ceramic hob and cause irreversible damage. Any spillages should be cleaned up as they happen.
- Do not place pans with a wet bottom on the warmed up heating zones as this can cause irreversible changes to the hob (irremovable stains).
- Use pans that are specified by the manufacturer as designed for use with a ceramic hob.
- If any defects, deep scratches, cracks or chips appear on the ceramic hob, stop using the cooker immediately and contact the service centre.
- Do not switch on the hob until a pan has been placed on it.
- Do not use pans with sharp edges that may cause damage to the ceramic hob.
- Do not look directly at the halogen heating zones (not covered by a pan) when they are warming up.
- Do not put pans weighing over 15 kg on the opened door of the oven and pans over 25 kg on the hob.
- Do not use harsh cleaning agents or sharp metal objects to clean the door as they can scratch the surface, which could then result in the glass cracking.

## SAFETY INSTRUCTIONS

---

- Do not use the cooker in the event of a technical fault. Any faults must be fixed by an appropriately qualified and authorised person.
- In the event of any incident caused by a technical fault, disconnect the power and report the fault to the service centre to be repaired.
- The rules and provisions contained in this instruction manual should be strictly observed. Do not allow anybody who is not familiar with the contents of this instruction manual to operate the cooker.
- The appliance has been designed only for cooking. Any other use (for example for heating) does not comply with its operating profile and may cause danger.

## HOW TO SAVE ENERGY

---



Using energy in a responsible way not only saves money but also helps the environment. So let's save energy! And this is how you can do it:

- **Use proper pans for cooking.**  
Pans with thick, flat bases can save up to 1/3 on electric energy. Remember to cover pans if possible otherwise you will use four times as much energy!
- **Match the size of the saucepan to the surface of the heating zone.**  
A saucepan should never be smaller than a heating zone.
- **Ensure heating zones and pan bases are clean.**  
Soils can prevent heat transfer – and repeatedly burnt-on spillages can often only be removed by products which cause damage to the environment.
- **Do not uncover the pan too often (a watched pot never boils!).**  
Do not open the oven door unnecessarily often.
- **Switch off the oven in good time and make use of residual heat.**  
For long cooking times, switch off heating zones 5 to 10 minutes before finishing cooking. This saves up to 20% on energy.
- **Only use the oven when cooking larger dishes.**  
Meat of up to 1 kg can be prepared more economically in a pan on the cooker hob.
- **Make use of residual heat from the oven.**  
If the cooking time is greater than 40 minutes switch off the oven 10 minutes before the end time.
- **Make sure the oven door is properly closed.**  
Heat can leak through spillages on the door seals. Clean up any spillages immediately.
- **Do not install the cooker in the direct vicinity of refrigerators/freezers.**  
Otherwise energy consumption increases unnecessarily.

## UNPACKING



During transportation, protective packaging was used to protect the appliance against any damage. After unpacking, please dispose of all elements of packaging in a way that will

not cause damage to the environment.

All materials used for packaging the appliance are environmentally friendly; they are 100% recyclable and are marked with the appropriate symbol.

Caution! During unpacking, the packaging materials (polythene bags, polystyrene pieces, etc.) should be kept out of reach of children.

## DISPOSAL OF THE APPLIANCE



Old appliances should not simply be disposed of with normal household waste, but should be delivered to a collection and recycling centre for electric and electronic equipment. A symbol

shown on the product, the instruction manual or the packaging shows that it is suitable for recycling.

Materials used inside the appliance are recyclable and are labelled with information concerning this. By recycling materials or other parts from used devices you are making a significant contribution to the protection of our environment.

Information on appropriate disposal centres for used devices can be provided by your local authority.



## DESCRIPTION OF THE APPLIANCE

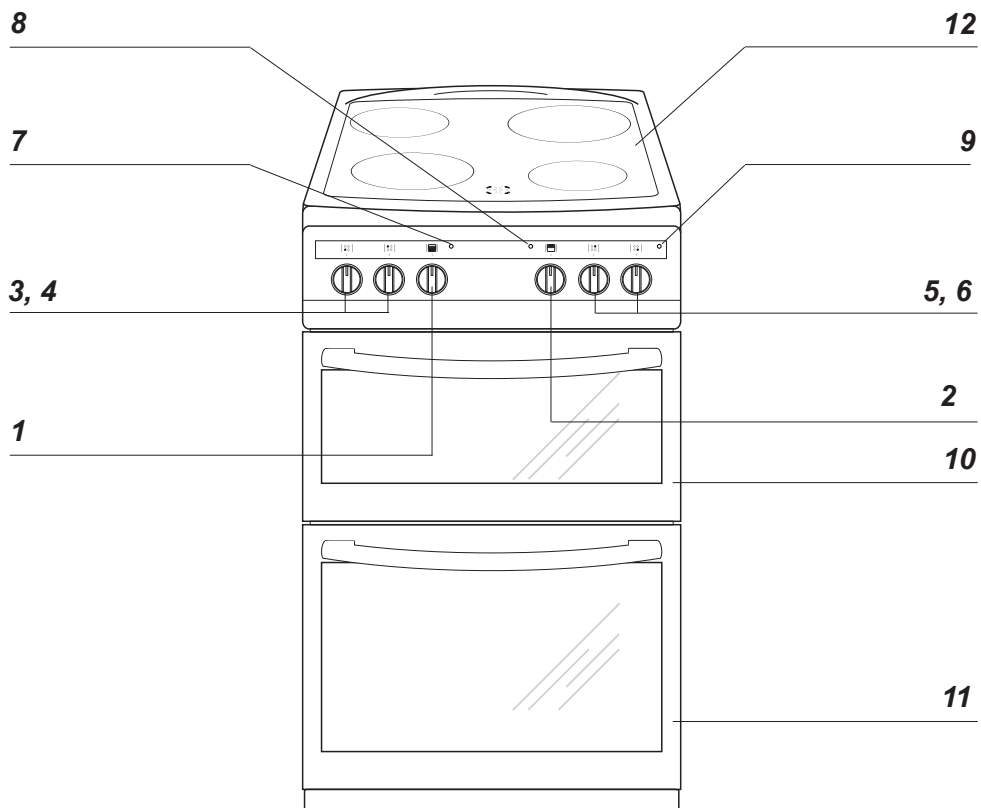

- 1** Temperature control knob - main oven
- 2** Temperature control knob - top oven
- 3, 4, 5, 6** Heating zone control knobs
- 7** Red thermostat light - main oven
- 8** Red thermostat light - top oven
- 9** Yellow operation light
- 10** Top oven door
- 11** Main oven door
- 12** Ceramic hob

# SPECIFICATIONS OF THE APPLIANCE

---

Cooker fittings:

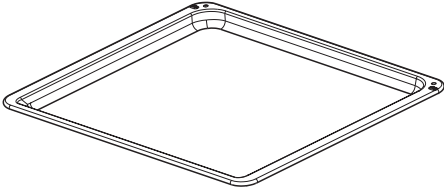

*Baking tray*

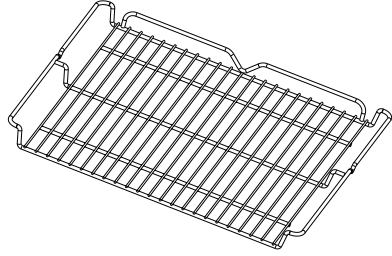

*Wire Shelf*

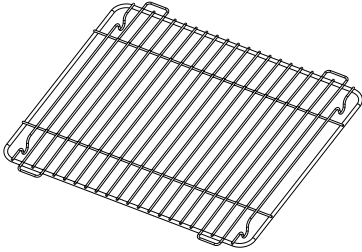

*Grill Rack*



*Cover Controls*

\*All images are for indication only; please refer to your individual unit for actual item.

# INSTALLATION

## Installing the cooker

- The kitchen should be dry and airy and have effective ventilation according to the existing technical provisions.
- The room should be equipped with a ventilation system that pipes away exhaust fumes created during combustion. This system should consist of a ventilation grid or hood. Hoods should be installed according to the manufacturer's instructions. The cooker should be placed so as to ensure free access to all control elements.
- Coating or veneer used on fitted furniture must be applied with a heat resistant adhesive (100°C). This prevents surface deformation or detachment of the coating. If you are unsure of your furniture's heat resistance, you should leave approximately 2 cm of free space around the cooker. The wall behind the cooker should be resistant to high temperatures. During operation, its back side can warm up to around 50°C above the ambient temperature.
- The cooker should stand on a hard, even floor (do not put it on a base).
- Before you start using the cooker it should be leveled, which is particularly important for fat distribution in a frying pan. To this purpose, adjustable feet are accessible after removal of the drawer. The adjustment range is +/- 5 mm.

## Anti-tilt protection

**CAUTION!** You must install the anti-tilt protection. If you do not install it, the appliance can tilt.

The appliance must be secured by using the safety chain (supplied and mounted to cooker rear).

Fasten hook to the kitchen wall and connect safety chain to the hook.

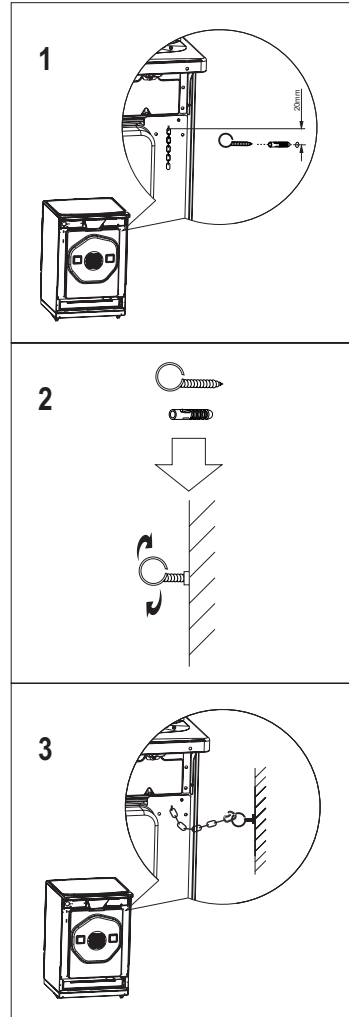

# INSTALLATION

## Electrical connection

**Warning:** This appliance must be earthed.

The appliance must be installed by a competent electrician using a double pole control unit of 32 ampere minimum capacity with 3 mm minimum contact separation at all poles.

We recommend that the appliance is connected by a qualified electrician who is member of the N.C.E.I.C. and who will comply with the I.E.E. and local regulation.

- Access to the main terminal is gained by opening the terminal block cover at the rear of the appliance (use a small flat-bladed screwdriver).
- Connection should be made with 4 mm<sup>2</sup> twin and earth cable.
- First strip the wires, then push the cable through the cable clamp in the terminal block cover.
- Connect the cable to the terminal block and tighten the cable clamp screw (see diagram).
- Ensure the cable exits through the cable grip clamping on the outer sheath of the cable and fix in place by tightening the fixing screw.
- Ensure all screws are adequately tightened. Do not over tighten as you may risk damaging the screw threads.
- Close the terminal box, ensuring that the cover is engaged on the locking tabs.
- The supply cable must be positioned away from any hot parts of the rear of the cooker. If this cannot be done then another method of protecting the supply cable from the hot parts must be used i.e. Heat resistant sleeving or high temperature cables.

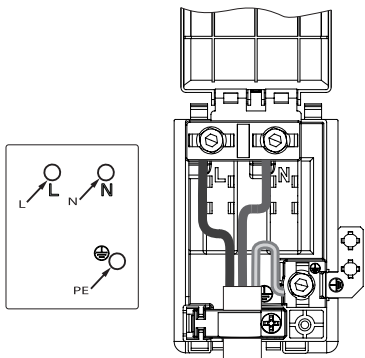

**220-240V 1N~**

- L - Live (Red or Brown)
- N - Neutral (Black or Blue)
- PE - Earth (Green/Yellow or sleeving)

Grounding lead must be connected to screw with  symbol.

- The power supply cable must have these minimum requirements:
- Type: HO5VV-F (PVC insulated and sheathed flexible cable)
  - 3 cores x 4 mm<sup>2</sup> .

# OPERATION

---

## Before first use

- Remove packaging, clean the interior of the oven and the hob.
- Take out and wash the oven fittings with warm water and a little washing-up liquid.
- Switch on the ventilation in the room or open a window.
- Heat the oven (to a temperature of 250°C, for approx. 30 min.), remove any stains and wash carefully; the heating zones of the hob should be heated for around 4 min. without a pan.

### **Important!**

To clean the oven, only use a cloth well rang out with warm water to which a little washing-up liquid has been added.

# OPERATION

## Controlling the heating zones of the ceramic hob.

### Choice of cookware

Choose a pan with a diameter that is at least as large as the heating zone. **Do not use pans with a concave or convex base.** Always remember to put a proper cover on the pan. We recommend the use of pans with thick, even bases. If the heating zones and pans are solid it is impossible to make full use of the heat.

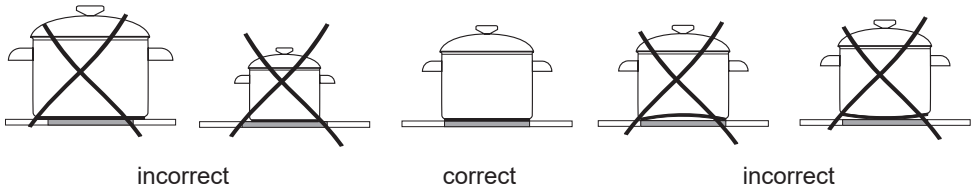

### Heat level selection

The heating zones have different levels of heat. The level of heat can be adjusted gradually by turning the appropriate knob to the right or left.

- 0        Switch off
- MIN. Warming up
- 1        Stewing vegetables, slow cooking
- Cooking soups, larger dishes
- 2        Slow frying
- Grilling meat, fish
- 3        MAX. Fast heating up, fast cooking, frying

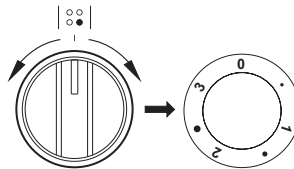

# OPERATION

---

## Zone heating indicator

---

If the temperature of a heating zone exceeds 50°C this is signalled by an indicator which lights up for that zone.

When the heating indicator lights up it warns the person using the cooker against touching a hot heating zone.

For about 5 to 10 minutes after a heating zone is switched off it will still have residual heat that can be used, for example to warm up or keep dishes warm without switching on another heating zone.

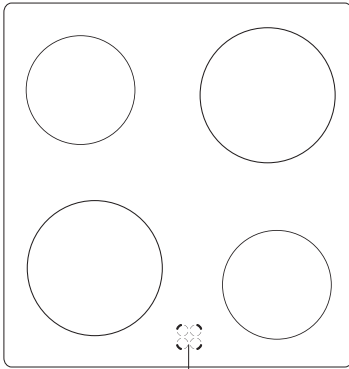

*Zone heating indicator*

# OPERATION

## Top oven functions and operations

### Natural convection oven (conventional).

The oven can be warmed up using the grill heater. Operation of the oven is controlled by the temperature regulator knob.

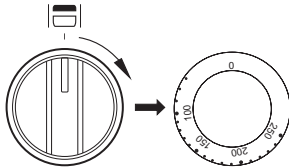

### Oven on and off

In order to switch on the oven you need to:

- set the knob to the required temperature, turning it right.

Switching on the oven is indicated by two signal lights, yellow and red, turning on. The yellow light turned on means the oven is working. If the red light goes out, it means the oven has reached the set temperature. If a recipe recommends placing dishes in a warmed-up oven, this should be not done before the red light goes out for the first time. When baking, the red light will temporarily come on and go out (to maintain the temperature inside the oven). Switching off the oven – in order to switch off the oven, set the knob to the “0” knob position, turning it left. The signal light should go out.

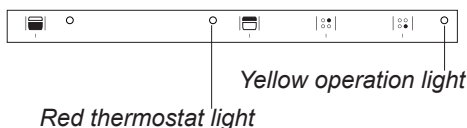

### Grill on, the oven door is open.

The thermostat enables the user to set the temperature within a range from 100°C to 250°C. Grilling is used for cooking of small portions of meat: steaks, schnitzel, fish, toasts, Frankfurter sausages, (thickness of roasted dish should not exceed 2-3 cm and should be turned over during roasting). For grilling with the function grill the temperature must be set to 250°C.

### Warning!

The door of the oven should be open while grilling. Put the knob cover on.

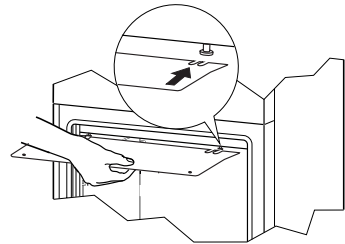

Accessible parts may become hot during use. Young children should be kept away.

### Oven lighting

The main oven lamp will be switched on after the temperature has been set by the temperature regulator knob.





# OPERATION

## Main oven functions and operations

### Oven with automatic air circulation.

The oven can be warmed up using the ring heating element and rotating fan. Operation of the oven is controlled by the temperature regulator knob.

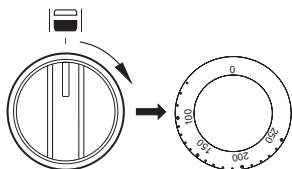

### Oven on and off

In order to switch on the oven you need to:

- set required working conditions of the oven, its temperature and a mode of heating,
- set the knob to the required position, turning it right.

Switching on the oven is indicated by two signal lights, yellow and red, turning on. The yellow light turned on means the oven is working. If the red light goes out, it means the oven has reached the set temperature. If a recipe recommends placing dishes in a warmed-up oven, this should be not done before the red light goes out for the first time. When baking, the red light will temporarily come on and go out (to maintain the temperature inside the oven). Switching off the oven – in order to switch off the oven, set the knob to the “0” knob position, turning it left. The signal light should go out.



### Convection with ring heating element

The thermostat enables the user to set the temperature within a range from 100°C to 250°C. The oven is heated up by a heating element with air circulation forced by a rotating fan fitted in the central part of the back wall of the chamber. Lower baking temperatures than in the conventional oven can be used.

Heating the oven up in this manner ensures uniform heat circulation around the dish being cooked in the oven.

### Oven lighting

The main oven lamp will be switched on after the temperature has been set by the temperature regulator knob.

## BAKING IN THE OVEN – PRACTICAL HINTS

---

### Baking













- we recommend using the accessories which were provided with your cooker;
- it is also possible to bake in cake tins and trays bought elsewhere which should be put on the drying rack; for baking it is better to use black trays which conduct heat better and shorten the baking time;
- shapes and trays with bright or shiny surfaces are not recommended when using the conventional heating method (top and bottom heaters), use of such tins can result in undercooking the base of cakes;
- when using the ultra-fan function it is not necessary to initially heat up the oven chamber, for other types of heating you should warm up the oven chamber before the cake is inserted;
- before the cake is taken out of the oven, check if it is ready using a wooden stick (if the cake is ready the stick should come out dry and clean after being inserted into the cake);
- after switching off the oven it is advisable to leave the cake inside for about 5 min.;
- temperatures for baking with the ultra-fan function are usually around 20 – 30 degrees lower than in normal baking (using top and bottom heaters);
- the baking parameters given in Table are approximate and can be corrected based on your own experience and cooking preferences;
- if information given in recipe books is significantly different from the values included in this instruction manual, please apply the instructions from the manual.

### Roasting meat

- cook meat weighing over 1 kg in the oven, but smaller pieces should be cooked on the gas burners.
- use heatproof ovenware for roasting, with handles that are also resistant to high temperatures;
- when roasting on the drying rack or the grate we recommend that you place a baking tray with a small amount of water on the lowest level of the oven;
- it is advisable to turn the meat over at least once during the roasting time and during roasting you should also baste the meat with its juices or with hot salty water – do not pour cold water over the meat.

## BAKING IN THE OVEN – PRACTICAL HINTS

### Oven with automatic air circulation (including a fan and an ultra-fan heater)

Type of dish	Oven functions	Temperature °C	Level ( 1 )	Time in minutes 
		140 - 160	2 - 3	10 - 40*
		200 - 230	1 - 3	10 - 20
		160 - 180	2 - 3	45 - 60
		160 - 180	2	120 - 160
		160 - 190	2	90 - 120
		175 - 190	2	60 - 70

\* Baking smaller items

#### Caution!

The figures given in Tables are approximate and can be adapted based on your own experience and cooking preferences.

## CLEANING AND MAINTENANCE

---

By ensuring proper cleaning and maintenance of your cooker you can have a significant influence on the continuing fault-free operation of your appliance.

**Before you start cleaning, the cooker must be switched off and you should ensure that all knobs are set to the “●”/“0” position. Do not start cleaning until the cooker has completely cooled.**

### Ceramic hob

- The hob should be cleaned regularly after each use. If possible, it is recommended that the hob is washed while still warm (after the heating zone indicator goes off). Do not allow the hob to get heavily stained; particularly from burnt-on spillages from boiled over liquids.
- When cleaning do not use cleaning agents with a strong abrasive effect, such as e.g. scouring powders containing an abrasive, abrasive compounds, abrasive stones, pumice stones, wire brushes and so on. They may scratch the hob surface, causing irreversible damage.
- Large spillages that are firmly stuck to the hob can be removed by a special scraper; but be careful not to damage the ceramic hob frame when doing this.

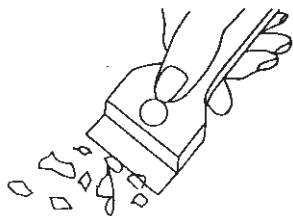

*Scraper for cleaning the hob*

**Caution! The sharp blade should always be protected by adjusting the cover (just push it with your thumb). Injuries are possible so be careful when using this instrument – keep out of reach of children.**

### Important!

**Do not use any abrasive agents, harsh detergents or abrasive objects for cleaning.**

**Only use warm water with a small addition of dishwashing liquid to clean the front of the appliance. Do not use washing powders or creams.**

# CLEANING AND MAINTENANCE

---

## Oven

- The oven should be cleaned after every use. When cleaning the oven the lighting should be switched on to enable you to see the surfaces better.
- The oven chamber should only be washed with warm water and a small amount of washing-up liquid.

### Caution!

Do not use cleaning products containing abrasive materials for the cleaning and maintenance of the glass front panel.

## Replacement of the oven light bulb

**In order to avoid the possibility of an electric shock ensure that the appliance is switched off before replacing the bulb.**

- Set all control knobs to the position “●”/“0” and disconnect the mains plug,
- unscrew and wash the lamp cover and then wipe it dry.
- unscrew the light bulb from the socket, replace the bulb with a new one – a high temperature bulb (300°C) with the following parameters:
  - voltage 230 V
  - power 25 W
  - thread E14.

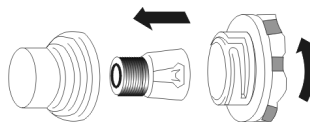

- Screw the bulb in, making sure it is properly inserted into the ceramic socket.
- Screw in the lamp cover.

# CLEANING AND MAINTENANCE

## Removing the Top Oven Door

In order to obtain easier access to the oven chamber for cleaning, it is possible to remove the door. To do this, tilt the safety catch part of the hinge upwards (fig. A). Close the door lightly, lift and pull it out towards you. In order to fit the door back on to the cooker, do the inverse. When fitting, ensure that the notch of the hinge is correctly placed on the protrusion of the hinge holder. After the door is fitted to the oven, the safety catch should be carefully lowered down again. If the safety catch is not set it may cause damage to the hinge when closing the door.

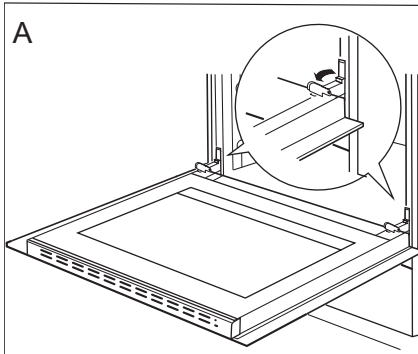

*Tilting the hinge safety catches*

## Removing the inner panel

1. Using a flat screwdriver unhook the upper door slat, prying it gently on the sides (fig. B).
2. Pull the upper door slat loose. (fig. B, C)

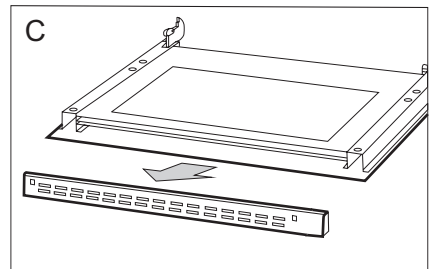
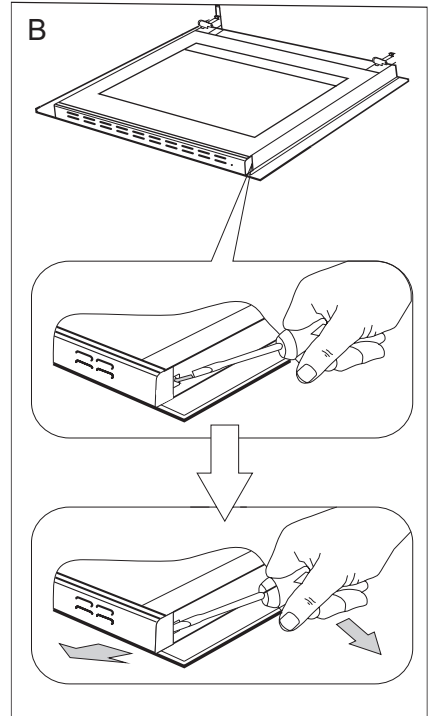

## CLEANING AND MAINTENANCE

3. Pull the inner glass panel from its seat (in the lower section of the door). Remove the inner panel (fig. D, D1).

4. Clean the panel with warm water with some cleaning agent added.

Carry out the same in reverse order to reassemble the inner glass panel. Its smooth surface shall be pointed upwards.

**Important! Do not force the upper strip in on both sides of the door at the same time.** In order to correctly fit the top door strip, first put the left end of the strip on the door and then press the right end in until you hear a “click”. Then press the left end in until you hear a “click”.

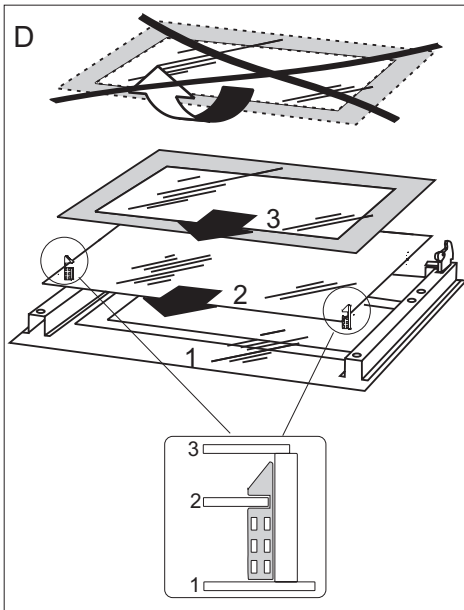

*Removal of the internal glass panel.  
3 glass panel.*

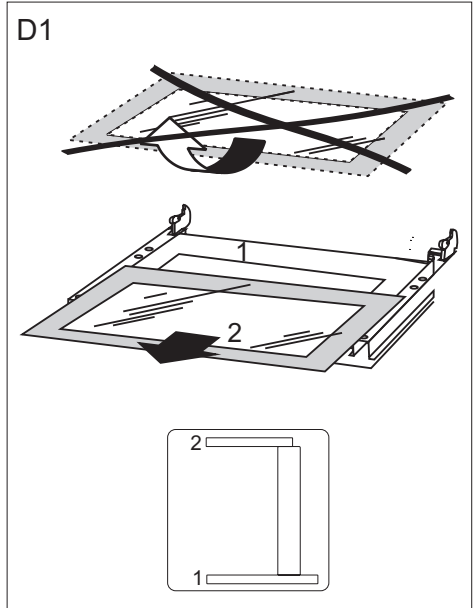

*Removal of the internal glass panel.  
2 glass panel.*

## OPERATION IN CASE OF EMERGENCY

---

In the event of an emergency, you should:

- switch off all working units of the cooker
- disconnect the mains plug
- call the service centre
- some minor faults can be fixed by referring to the instructions given in the table below. Before calling the customer support centre or the service centre check the following points that are presented in the table.

PROBLEM	REASON	ACTION
1. electrical fittings do not work	break in power supply	check the household fuse box, if there is a blown fuse replace it with a new one
2. the programmer display is flashing "0.00".	the appliance was disconnected from the mains or there was a temporary power cut.	set the current time (see ' <i>Use of the programmer</i> ').
3. the oven lighting does not work	the bulb is loose or damaged	tighten up or replace the blown bulb (see Chapter <i>Cleaning and Maintenance</i> )

### Regular inspections

Besides keeping the cooker clean, you should:

- carry out periodic inspections of the control elements and cooking units of the cooker. After the guarantee has expired you should have a technical inspection of the cooker carried out at a service centre at least once every two years,
- fix any operational faults,
- carry out periodical maintenance of the cooking units of the cooker.

#### **Caution!**

All repairs and regulatory activities should be carried out by the appropriate service centre or by an appropriately authorised fitter.



## TECHNICAL DATA

Model	AFC5100WH AFC5100SI
Rated Voltage	220-240V~
Rated Frequency	50 Hz
Power	9800 W
Ceramic hob	5800 W
Top oven	2000 W
Grill	2000 W
Main oven	2000 W
Ring element	2000 W
External Dimensions (W x D x H)	500(W) x 600(D) x 900(H) mm

### *Certificate of compliance CE*

*The Manufacturer hereby declares that this product complies with the general requirements pursuant to the following European Directives:*

- *The Low Voltage Directive 2014/35/EC,*
- *Electromagnetic Compatibility Directive 2014/30/EC,*
- *ErP Directive 2009/125/EC,*

*and therefore the product has been marked with the **CE** symbol and the **Declaration of Conformity** has been issued to the manufacturer and is available to the competent authorities regulating the market.*





**Amica S.A.**

ul. Mickiewicza 52, 64-510 Wronki, Poland  
tel. +48 67 25 46 100, fax +48 67 25 40 320  
[www.amica.pl](http://www.amica.pl)

---