

Amica

AWDI914GJ

OPERATING INSTRUCTIONS

WASHER DRYERS

Please carefully read these Operating Instructions before using the appliance!

CONTENTS

Basic Information.....	3
Notes on safety.....	4
Install the appliance.....	8
Understanding the symbols on clothes labels.....	10
Display and control panel.....	11
Additional functions.....	21
Special programmes.....	29
Using the appliance.....	30
Table of programmes.....	34
Selecting sub-programmes.....	35
Troubleshooting.....	40
Maintenance and Cleaning.....	42
Practical tips on washing.....	46
Specification.....	49
Service and Warranty.....	49
Product fiche.....	50



In accordance with European Directive **2012/19/UE** and Polish legislation regarding used electrical and electronic goods, this appliance is marked with the symbol of the crossed-out waste container.

This marking indicates that the appliance must not be disposed of together with other household waste after it has been used.

The user is obliged to hand it over to waste collection centre collecting used electrical and electronic goods. The collectors, including local collection points, shops and local authority departments provide recycling schemes. Proper handling of used electrical and electronic goods helps avoid environmental and health hazards resulting from the presence of dangerous components and the inappropriate storage and processing of such goods.

BASIC INFORMATION

Dear customer,

From today, washing will be easier than ever before. Your Amica washer-dryer is exceptionally easy to use and extremely efficient. After reading these Operating Instructions, operating the appliance will be easy.

Before being packaged and leaving the manufacturer, the appliance was thoroughly checked with regard to safety and functionality. After these tests some moisture or water may remain in the appliance.

Before using the appliance, please read these Operating Instructions carefully

Following the directions in this manual will ensure proper operation and safe use of the appliance.

It is important to keep these Operating Instructions and store them in a safe place so that they can be consulted at any time.

Follow these instructions carefully in order to avoid possible accidents.



Important!

This washer-dryer is intended for domestic use only to wash and dry textiles and clothes designed to be machine washed in a detergent bath.

Before plugging the washer-dryer into the mains, remove the safety packaging and ensure the machine is level.

The manufacturer reserves the right to introduce changes which do not affect the operation of the appliance.

Use

- Carefully read the instructions below before using the appliance.
- Never use the appliance outdoors or anywhere the temperature may fall below freezing.
- The appliance should not be operated by children or anyone who has not read the instructions.

Important! Temperatures below 0°C can damage the appliance!

In the event of the appliance being stored or transported in sub-zero temperatures, it should be left to acclimatise in a temperature above zero for 8 hours before being used.

Manufacturer's Declaration

The manufacturer hereby declares that this product meets the requirements of the following European directives:

- Low Voltage Directive **2014/35/EC**,
- Electromagnetic Compatibility (EMC) Directive **2014/30/EC**,

and has been marked with the  symbol and issued with a declaration of compliance made available to market regulators.

NOTES ON SAFETY

- Detergents Use only those detergents and additives which are designed for automatic washing machines, especially when using the **COTTON** programme.

Do not use any agents containing solvents, as these may damage certain parts of the appliance, or cause them to emit poisonous gases. There is also a risk of ignition and explosion.

- Load Washing Ensure no unwanted objects are placed inside the appliance. Completely empty all pockets in clothing to be washed and fasten buttons and zips. Place small, loose objects in a washing bag, or inside a pillow case, as they may be destroyed or else damage the drum or internal tank. Do not exceed the recommended maximum load of washing.

- Control Panel



Protect the control panel from water spillage.

Do not put washed clothes on top of the appliance!

NOTES ON SAFETY

- Transport Unplug the appliance before preparing it for transport. Do not transport the washer-dryer if drum locking bolts are not in place. See the chapter INSTALL THE APPLIANCE. Keep the appliance in upright position when transported.

Data plate indicating basic information about

- Data plate the washer-dryer is located at the top part of the rear casing.

- Dry

Do not dry clothes that have not been washed.

- Do not dry chemically washed garments or clothing, where stains were removed by chemicals.
- Do not dry clothes soiled with substances such as cooking oil, crude oil, acetone, alcohol, petrol, kerosene, stain removers, turpentine, wax.
- Before loading the clothes into the dryer, remove such contamination in hot water, using a large amount of washing detergent.
- Do not dry articles made of rubber foam, latex, water-resistant fabrics, raincoats, rubber mats, thermally formed products, clothing or pillows padded with foam rubber, as they may melt and damage other items or even damage the appliance. Please carefully read these operating instruction before installing the appliance. Damage caused by improper connections or use of the appliance is not covered by the warranty.

NOTE: There is a cooling phase at the end of the drying cycle. Therefore, do not turn off the appliance before the end of the drying cycle. Otherwise, quickly remove and hang clothes to cool.

Checking stability

Once the appliance is in position and levelled, it must be checked to ensure it rests firmly on all four legs.

In order to check this, press down each corner of the appliance in turn to see if it moves. Safe, long-term and reliable operation of the appliance depends on it being correctly positioned and level.

Important! Level the appliance, remove the drum locking bolts and wait 3 hours before using the appliance for the first time.

Important! Incorrect levelling, especially instability, may cause the to move around during operation.

This appliance can be used by children aged 8 years and older or by persons with physical, mental or sensory handicaps, or by those who are inexperienced or unfamiliar with the appliance, provided they are supervised or have been instructed how to safely use the appliance and are familiar with risks associated with the use of the appliance.

Ensure that children do not play with the appliance.

Cleaning and maintenance of the appliance should not be performed by children unless they are 8 years or older and are supervised by a competent person.

Children of less than 3 years should be kept away unless continuously supervised.

DISPOSAL OF THE APPLIANCE

To ensure safety, the washing machine must be rendered unsuitable for use once its useful life comes to an end.

First unplug it and then cut off the power lead. Scrap the appliance in line with local waste disposal legislation.

INSTALL THE APPLIANCE

I. Remove the transport protection (keep the locking bolts for future use, e.g. when moving house).

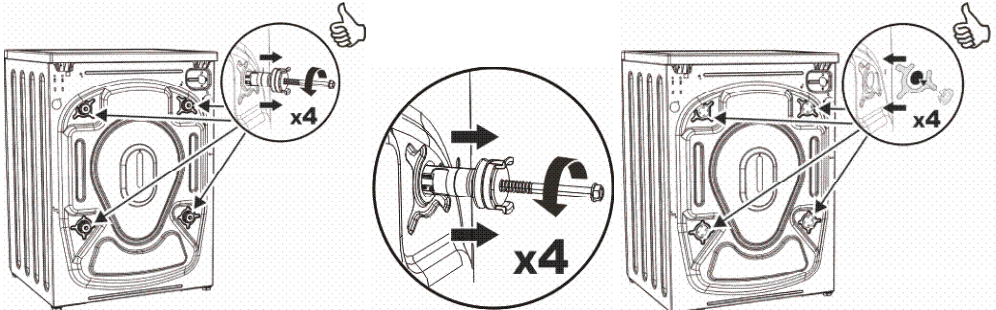

- Unscrew the 4 locking bolts with a spanner.
- Remove the rubber and plastic transport brackets from the sockets along with the washers and bolts.

- Stop up the holes with the stoppers enclosed in the accessories bag.



The locking bolts **MUST** be removed before the appliance is used!

II. Positioning and levelling the appliance



- Do not place the appliance on a carpet!
- The floor surface should not be either concave or sloping!
- Attention should be paid to the shape of the surface of the floor, so that the entire weight of the appliance rests on its legs (not its body)!

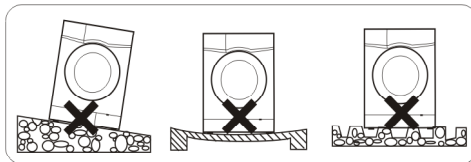

- Place the appliance on a solid, even surface.
- Level the machine by adjusting the legs.



After positioning and levelling the appliance, check that it is stable by pressing down each corner and ensuring it does not move!

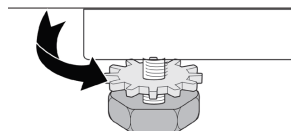
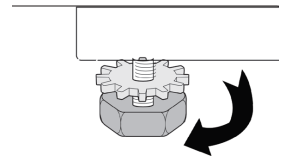

You can adjust the balance of your machine by the adjustable foot.

- Loosen the plastic adjustment nut.
- Adjust the feet upward and downward by rotating them.
- Tighten the plastic adjustment nut after balance is achieved.

INSTALL THE APPLIANCE

III. Connecting the water supply

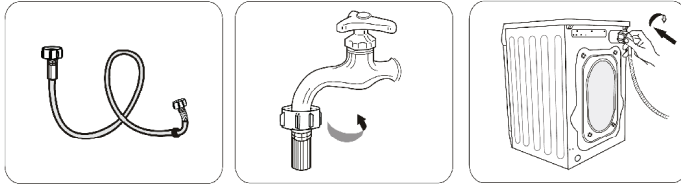

Use the new hoses supplied with the machine.
Do not re-use hoses.

A supply hose with seals is inside the drum of the dryer-washer.



Water pressure min 0.1 MPa (1 bar), max 1 MPa (10 bar).

Supply the machine with cold water

- after connecting, make sure the hose is not twisted
- after connecting the hose and the valve, check they are sealed tight
- regularly check the condition of the supply hose.

IV. Water drain

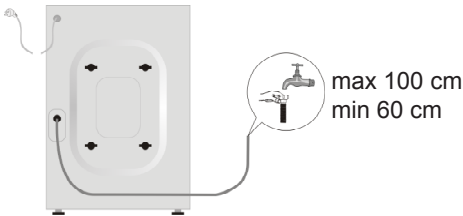

The drain hose is at the back of the machine. Fix the drain hose so that it does not move while the appliance is in operation (use the elbow as shown below). Do not place the hose too deep into the outlet pipe!

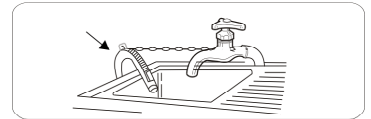

V. Connecting to power supply

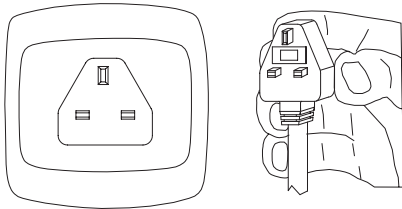

- The appliance's mains connection (electrical wall socket) should be in a visible and accessible place!
- Only plug the appliance into a properly installed socket with an earth pin!
- Do not connect to an adaptor or an extension cord!
- In the event of the power lead being damaged, it must be replaced by an authorised technician.
- The electrical system to which the appliance is to be connected must be protected with a 10 A fuse.

UNDERSTANDING THE SYMBOLS ON CLOTHES LABELS

	Sturdy Material		Ironing temperature maximum 110 °C
	Delicates fabric		No ironing
	Maximum washing temperature is 95 °C		Can be dry cleaned with all kinds of solvents
	Maximum washing water temperature 60 °C		Can be cleaned only with perchloride, lighter gas, alcohol or R113.
	Maximum washing water temperature 40 °C		Can be cleaned only with perchloride, lighter gas, alcohol or R113.
	Maximum washing water temperature 30 °C		No dry cleaning
	Hand washing		Leave on flat surface
	Dry cleaning only		Hang when wet
	Can be bleached in cold water		Dry by hanging
	Do not use bleach.		Drying in normal temperature dryer
	Ironing temperature maximum 200 °C		Low temperature
	Ironing temperature maximum 150 °C		Do not dry in drying

DISPLAY AND CONTROL PANEL

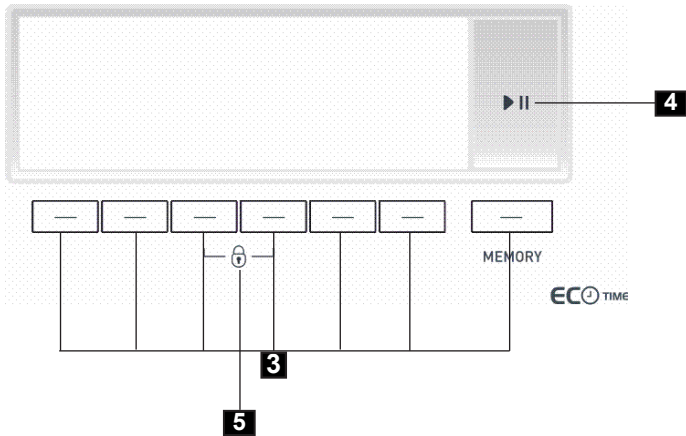
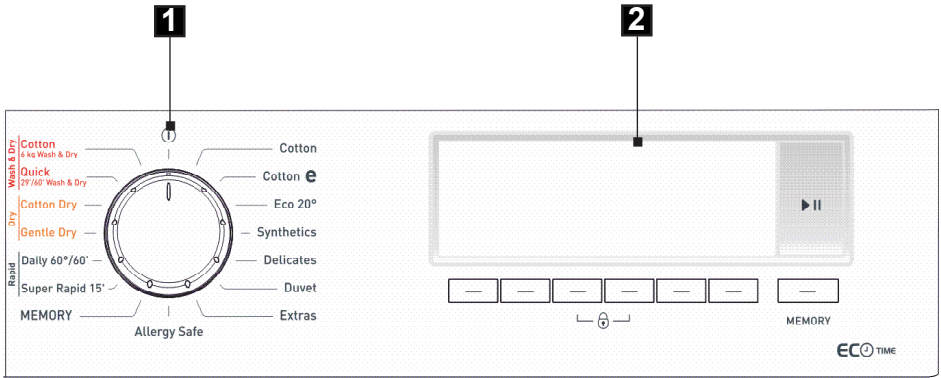

1. Programme selector knob
2. Display
3. Adjustment and additional function buttons
4. START/PAUSE button
5. Child Lock

DISPLAY AND CONTROL PANEL

To make the first settings of your washer-dryer:

- Plug in your machine.
- Open the water tap.
- Turn the programme knob.

Language selection setting

- The first thing that will be displayed on the main screen is the language selection setting.

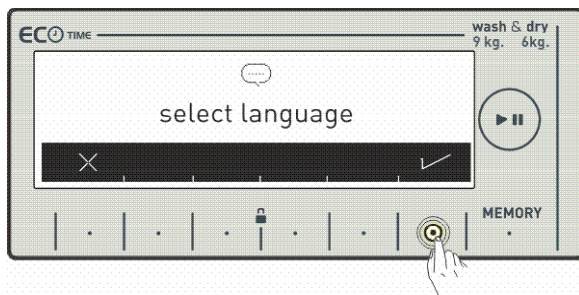

- Go to the language you wish the use with the [✓] symbol button.
- You can exit the language selection screen without making a selection with the [X] symbol button.

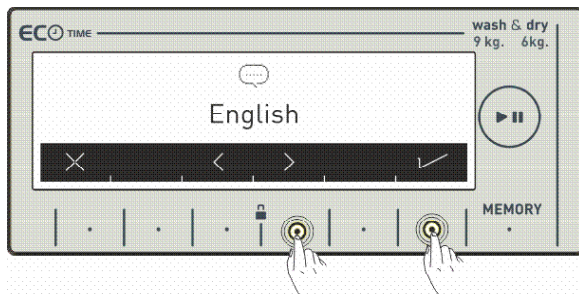

- Go to the language you wish the use with the [<] [>] symbol buttons.
- Approve your language selection with the [✓] symbol button.

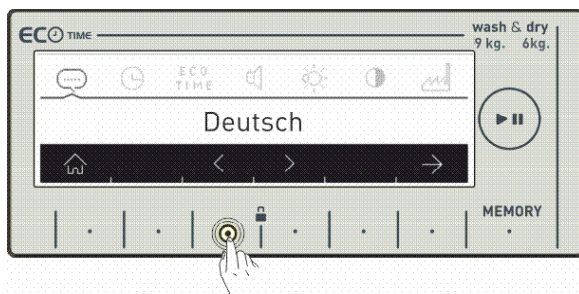

DISPLAY AND CONTROL PANEL

- When you want to change your language selection again, you can make the language selection by going into the language selection page and using the [<] [>] symbol buttons.

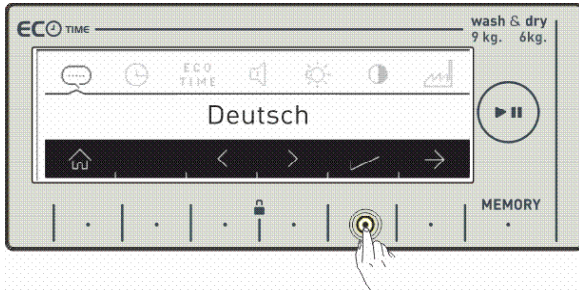

- Touch the [✓] button to save the language you selected.
- You will be asked to confirm the language selection on screen.

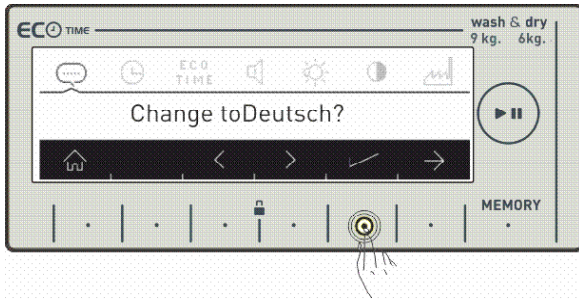

- Touch the [✓] button to approve the selection.
- If you believe you have selected the wrong language, touch the [X] button and re-make the language selection.
- When you approve the language change, the language you have selected will be active.

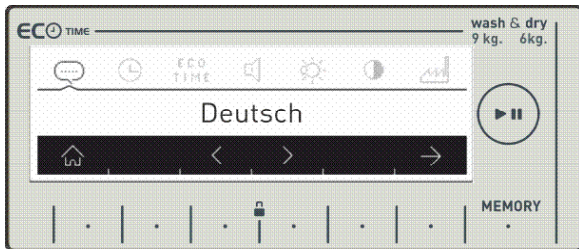

DISPLAY AND CONTROL PANEL

Eco Time Setting (Economic time interval)

• The electrical energy consumption cost changes during the day according to the time intervals set by electricity providers. You can learn these intervals from electricity providers and set your eco time running hours, and have your machine run between these hours you determined.

Note: Your mains electricity must be connected to a counter with a smart-counter feature to be able to provide this energy saving.

- Touch the [✓] symbol button to make this adjustment.
- If you want to do it later, touch the [X] symbol button.

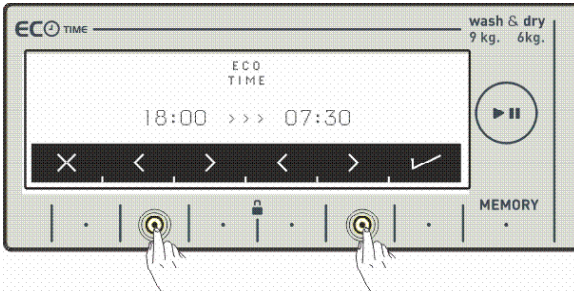
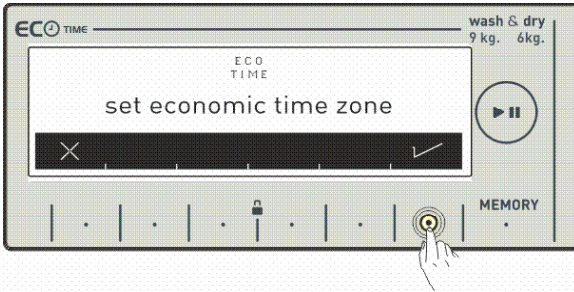

• You can adjust the Eco Time interval by touching the buttons of symbols [<] [>] see next pages to activate the Eco Time interval additional function.

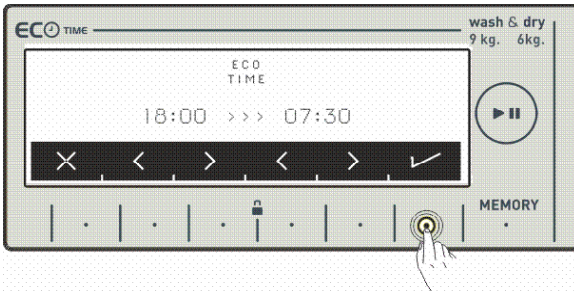

• Approve your selection by touching the [✓] symbol button.

DISPLAY AND CONTROL PANEL

Current time setting

- We advise that you set the correct time at the point of installation.

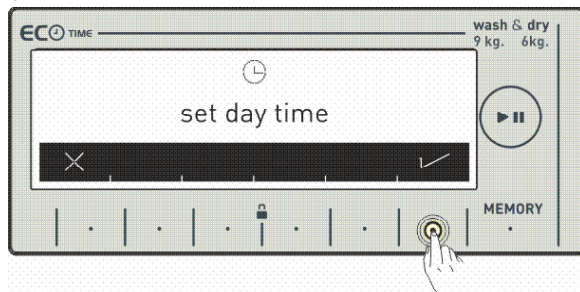

- Your machine will ask your approval for setting the current time. Go to the setting menu by touching the [✓] symbol button. [X] symbol button allows you to exit without setting.

Note: You must set the current time correctly. Otherwise, operation of other related functions will be affected.

Note: Recorded time information will be reset if you keep your machine unplugged for longer than 15 days. In such a case your machine will ask you again for the time setting when you next turn it on.

- Please make the current hour and minute settings by touching the [> >] symbol buttons.

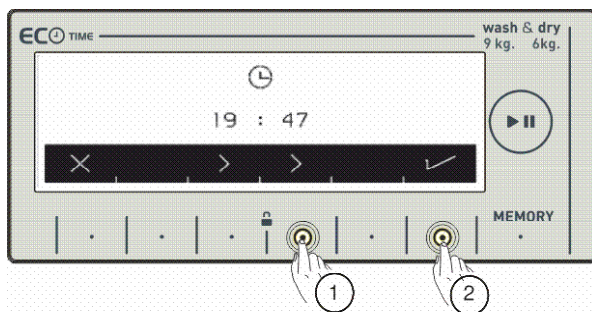

- After setting the current time, approve by pressing the [✓] symbol button.

DISPLAY AND CONTROL PANEL

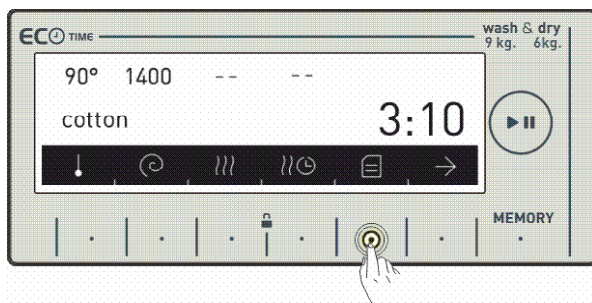

- Your machine will automatically go to the main screen of the programme you have selected. Go to the appliance settings menu by touching the button of  symbol on this screen.

Sound Adjustment

- You can make the sound adjustment of your appliance by pressing the [<] [>] symbol buttons.

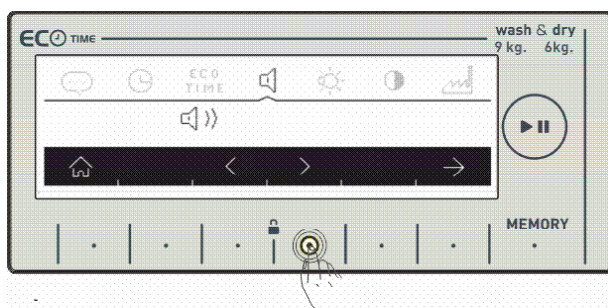

 symbol denotes that the warning sounds of your appliance is on.

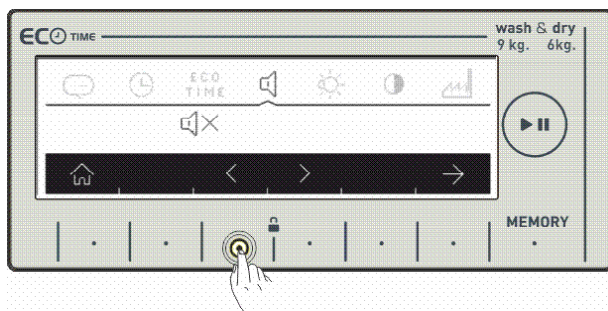

 symbol denotes that the warning sounds of your appliance are off.

DISPLAY AND CONTROL PANEL

Screen brightness setting

- You can adjust the screen brightness of your appliance by touching the [<] [>] symbols.

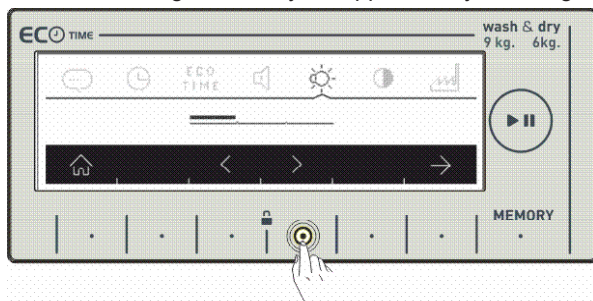

- Adjust the screen contrast of your appliance by touching the → symbol button.

Screen contrast setting

- You can adjust the screen contrast your appliance by touching the [<] [>] symbol buttons.

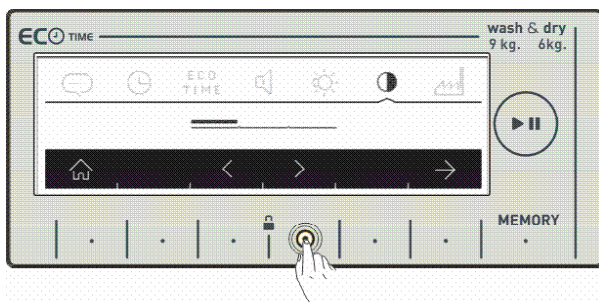

- You can go to the 'revert to factory settings' screen by touching the → symbol.

Revert to factory settings

If you want to revert your appliance to the factory default settings:

- Touch the ↻ symbol.

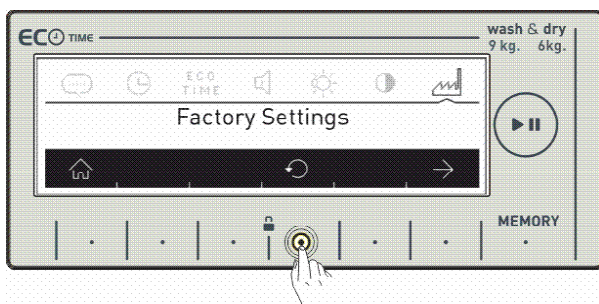

- You will be asked on screen if you want to reset to Factory Settings.

DISPLAY AND CONTROL PANEL

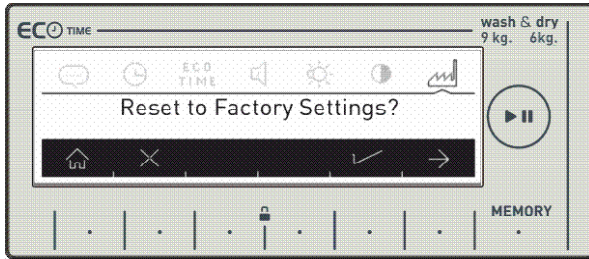



- Touch the [✓] symbol to approve the selection.
- If you want to cancel the selection touch the [X] symbol.
- You can return to the main screen by touching the  button.

Program selection

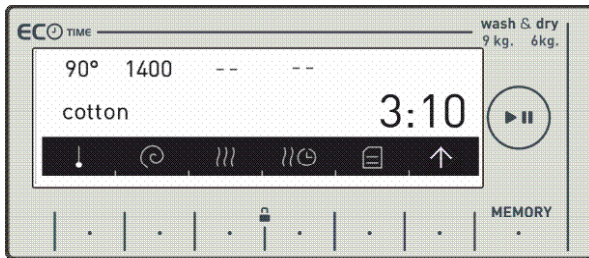
- The programme name and features will be shown on the screen.





- You can make the temperature adjustment (, 20°, 30°, 40°, 60°, 90°) by touching the  symbol button.
- You can make the spinning adjustment (, 400, 600, 800, 1000, 1200, 1400) by touching the symbol buttons.

Note: After setting the spin speed, if you select a drying programme, your machine shall set the spin speed automatically to enhance drying performance.

If you want your laundry dried at the end of washing

- You can select the drying setting you wish to use by touching the symbol  button.

Cupboard dry



- Recommended for laundry that you will put in the cupboard directly.
- If you want to select the cupboard dry feature, touch the  symbol button until you see the  symbol on the screen.

DISPLAY AND CONTROL PANEL

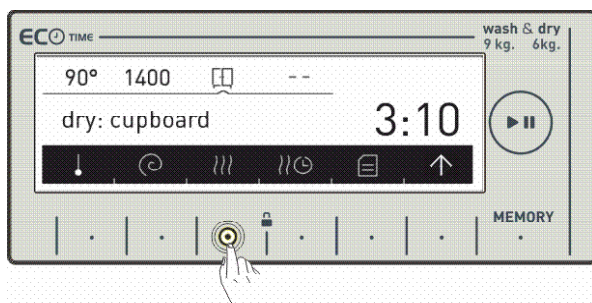
Note: If the  symbol does not appear on the screen when you want to select the cupboard dry function, it means this drying feature is not used in the washing programme you selected.



Hanger dry

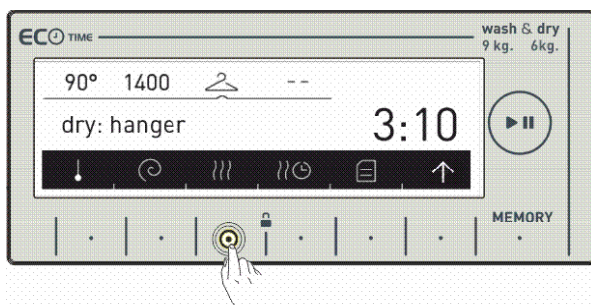

- Recommended for laundry that requires hanger drying.
- If you want to select the hanger dry feature, touch the symbol  button until you see the  symbol on the screen.

Note: If the  symbol does not appear on the screen when you want to select the hanger dry feature, it means that the washing programme you selected does not use this drying feature.



DISPLAY AND CONTROL PANEL

Iron dry

- Recommended for laundry that you will iron before use.
- If you want to select the iron dry feature, touch the  symbol button until you see the  symbol on the screen.

Note: If the  symbol does not appear on the screen when you want to select the iron dry feature, it means that the washing programme you selected does not use this drying feature.

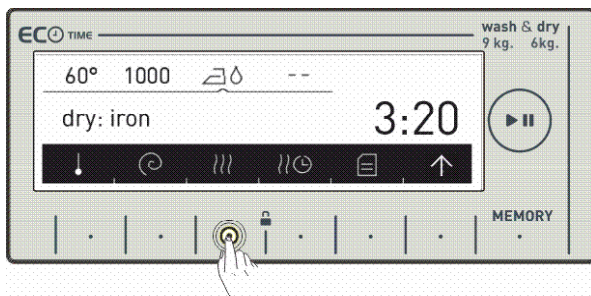

Drying with duration

If you want to use a time-set drying programme;

- Touch the  symbol on the screen.
- Drying selections will be displayed on your machine screen as 30, 60 and 120 minutes.

Note: If one of the symbols are not displayed on the screen when you wish to select the duration drying feature, it means this drying feature cannot be used in the programme you selected or the load amount in the machine is not appropriate for that duration of drying.

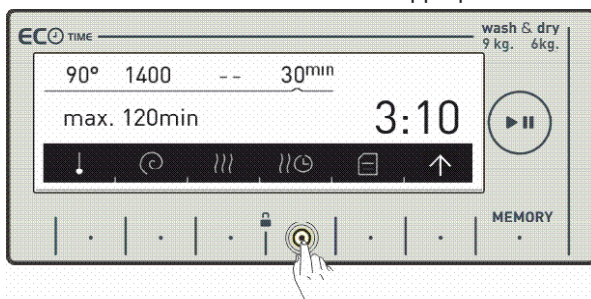

Duration Drying Programs

Amount of laundry to dry	Recommended drying time
1 kg	30 minutes
2 kg	60 minutes
3,5 kg	120 minutes

If the amount of laundry to be dried is above 3,5kg, it is advised that one of the options of Cupboard, Hanger or iron drying is selected.

ADDITIONAL FUNCTIONS

Before starting the programme, you can optionally select an additional function.

- Press the button of an additional function you would like to select.

Additional functions may not be available due to the programme you selected or the amount of laundry you put in your machine. Why an additional function may not be available:

- It is not compatible with a function you have selected previously.

- There may not be enough time left on the current programme to carry out the additional function you wish to select.



- Touch the  symbol button to arrive on the additional function view.

Pre-wash additional function

You can give your heavily soiled laundry a pre-wash before the main wash using this function. When using this function, you should put detergent in the front washing compartment of the detergent drawer.

- Touch the  symbol button to activate the pre-wash additional function.

Note: If the  symbol is not displayed on the screen when you want to choose the pre-wash additional function, it means that this feature can not be used in the washing programme you selected.

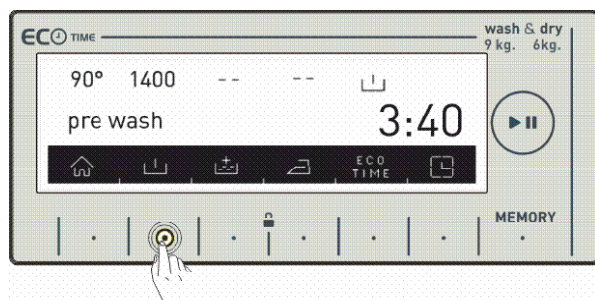



ADDITIONAL FUNCTIONS

Extra rinse function

You can add an additional rinse or rinses to your laundry by using this function. Your machine offers you 3 rinsing options for this additional feature.

 One additional rinse is made at the end of washing.

 Two additional rinses are made at the end of washing.

 Three additional rinses are made at the end of washing.

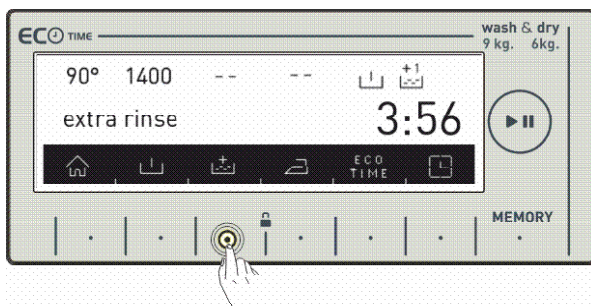

- If you want to make more than one rinsing, touch the  symbol button until you see the number of rinses you wish.

Note: If the  symbol is not displayed on the screen when you want to choose the additional rinsing function, it means that this feature is not used in the washing programme you selected.



Anti-allergic additional function

You can add this additional rinse operation to your laundry by using this function. Your machine will carry out all rinsing steps with hot water (it is recommended for laundry worn on delicate skin, baby clothes, underwear)

- Touch the  symbol button until you see the  symbol to activate the anti-allergic additional function.

Note: If the  symbol is not displayed on the screen when you want to select the anti-allergic additional function, it means that the washing programme you selected does not use this feature.

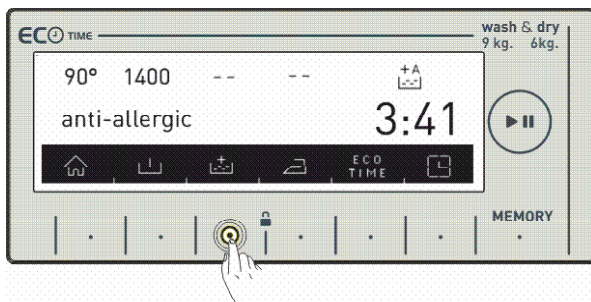

ADDITIONAL FUNCTIONS

Easy ironing additional function

- You can make your laundry be less wrinkled at the end of the wash by using this additional function.
- Touch the  symbol button to activate the easy ironing additional function.

Note: If the  symbol is not displayed on the screen when you want to select the easy ironing additional function, it means that the washing programme you selected does not use this feature.

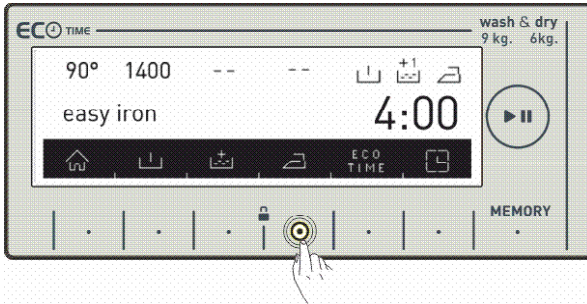

Economic time interval additional function

- You must make the Eco Time setting from the settings section for this function to work efficiently.
- If you want to activate the Eco Time function touch the button of ^{ECO} TIME symbol.
- You will see ^{ECO} TIME symbol is activated on the screen.

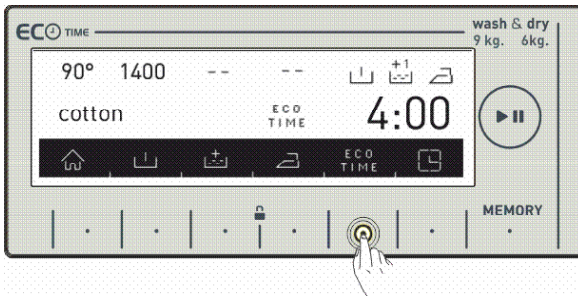

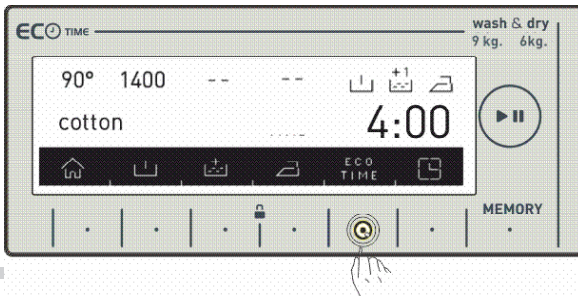

- The Eco Time feature will be constantly displayed on the screen until it is shut off. To shut off, the eco time additional function button must be pressed.

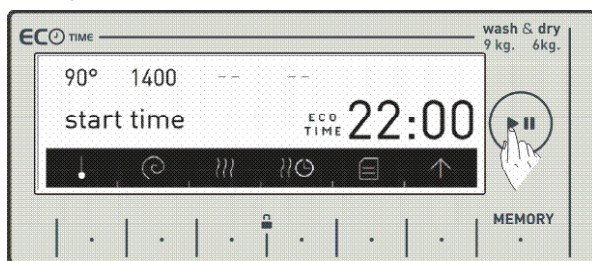

ADDITIONAL FUNCTIONS

- If you want to run a program while the eco time feature is active, touch the button of  symbol. The starting time of the programme will automatically be delayed until the economic time interval. The programme “starting time” and the programme duration will be shown on the display with certain intervals.



- If you don't want to run the programme you have selected between the eco time hours, touch the  button again. “eco time cancelled” text will be displayed on the screen.

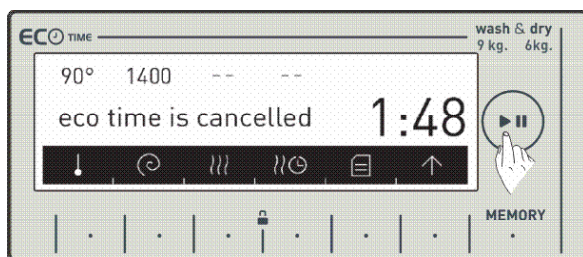

- Your machine will return to the main screen of the programme you have selected in 3 seconds. To start the programme, run the programme you selected by touching the start/pause button.

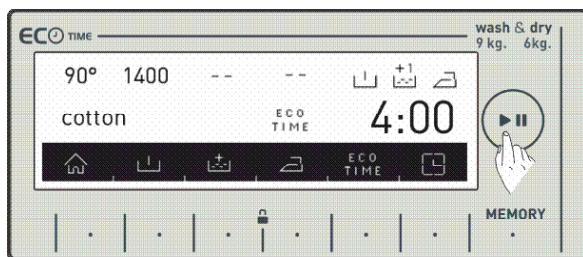

ADDITIONAL FUNCTIONS

Delay Time / Finish time adjustment additional function

• By using this function, you can delay your machine starting the washing operation by 10 minutes up to 23 hours 50 minutes or you can set the wash to finish at a certain time.

• To activate this additional function, touch the  symbol.

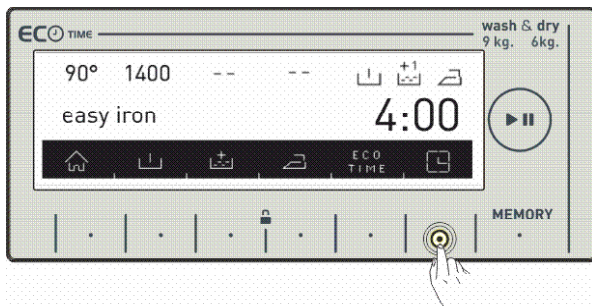

• The current time shall be displayed on the screen for a short duration.

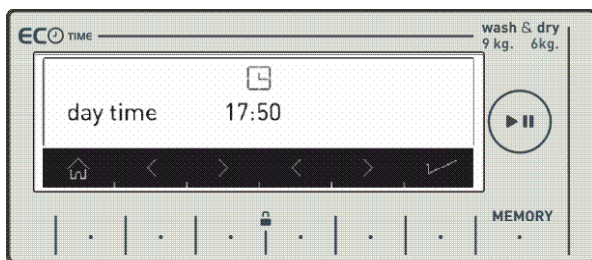

• The screen displaying the current time will automatically return to the screen that displays the delay time / finish time.

• On this screen, you can delay the washing time, or make the washing operation end at a time you wish by touching the [<] [>] symbol buttons.

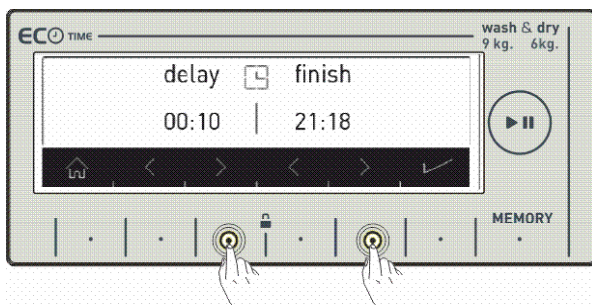

Note: The current time setting must be accurate to be able to use this function correctly.

ADDITIONAL FUNCTIONS

Memory record function button (MEMORY)

With this feature of your machine, you can store the washing and drying programme you have used before or programme settings you have performed before by simply touching a button without taking your time with this memory option. Thus, you can wash and dry your laundry without performing these settings again. Select the settings you would like to store in the memory on the display and touch the favorite record button.

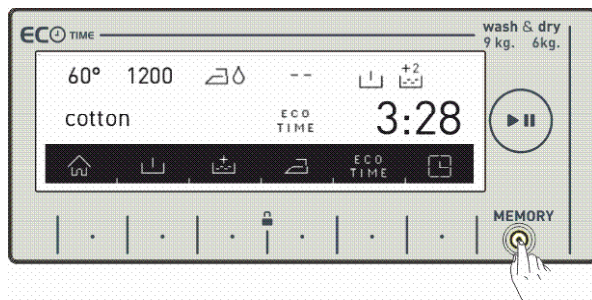

- If you would like to make changes on the washing and drying programme before storing, you can return to the programme menu by pressing [X] button.

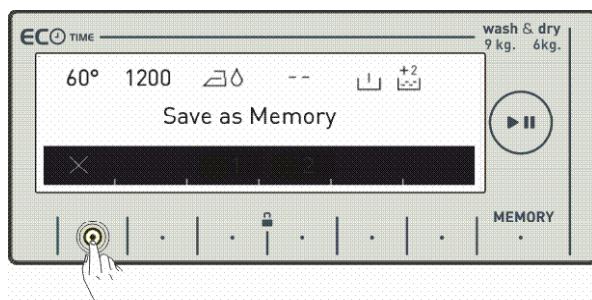

You can touch the favorite button again when you have performed the change you desire.

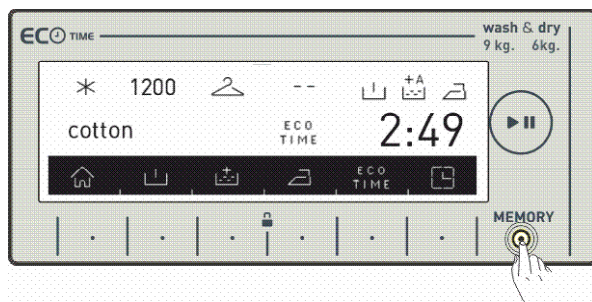

ADDITIONAL FUNCTIONS

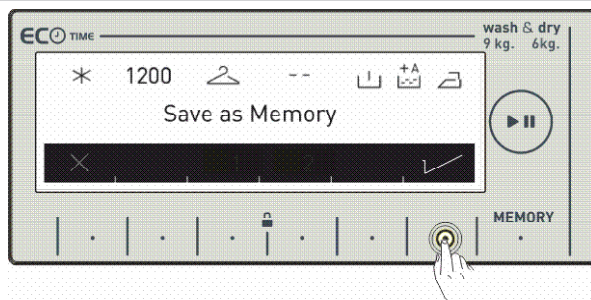

- You can store it by pressing [✓] symbol button.

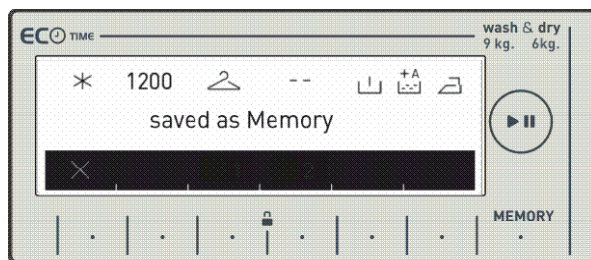

- A screen as shown above shall be displayed when the storing is complete and your machine shall automatically return to the main screen of the washing or drying programme where you performed the setting operation.
- You can wash your laundry or select other programme by pressing start/hold button to perform washing.

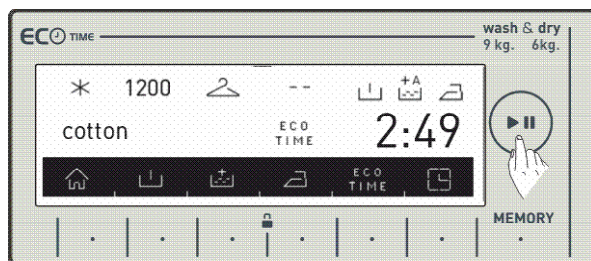

- If you would like to change the settings you have stored in the memory, select the memory option or perform the programme combination setting on any programme and touch the (MEMORY) button.

ADDITIONAL FUNCTIONS

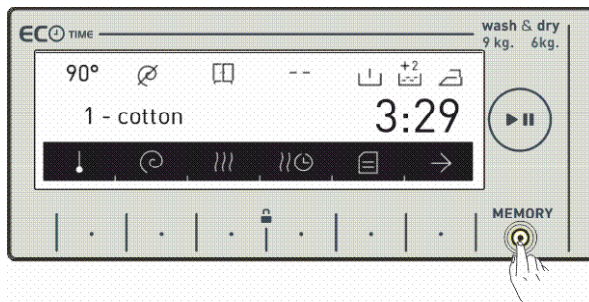

- If you would store a new programme on a previously stored programme, a confirmation dialog to confirm your selection shall be displayed on the screen, you can confirm your selection by pressing [✓] symbol button.

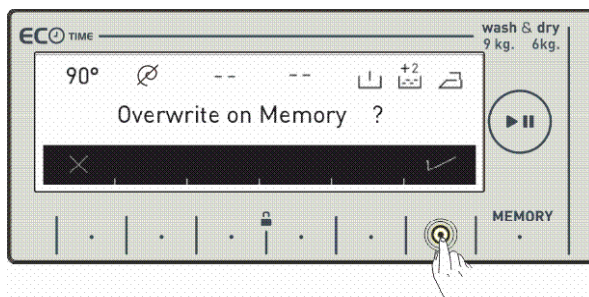

- This would allow you to store a new memory programme.

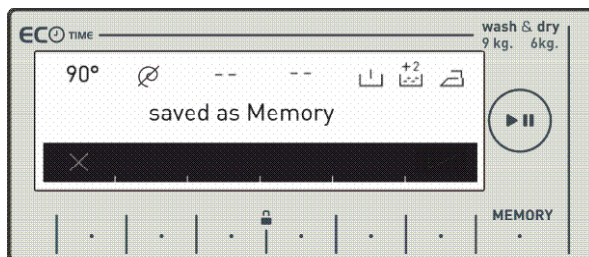

SPECIAL PROGRAMMES

1. **The Allergy Safe programme:**

This programme is designed for washing clothes of children and people with sensitive skin. Main wash is carried out at a temperature of 60°C (temperature setting: 90/60//40/30/20-- "cold water"), followed by four rinses.

Additionally, during all stages of rinsing water is heated to 30°C.

2. **Daily 60' 60°C:**

A daily wash programme with a duration of 60 minutes, the temperature setting of 60°C and a single rinse cycle and a maximum spin speed. Use this programme to wash coloured fabrics, cotton and linen.

3. **Super Rapid 15':**

Use these programmes to refresh clothes. They include all three wash stages:

- Main wash
- Rinse
- Spin

4. **Eco 20:**

Use this programme to wash clothes at 20°C.

5. **Drying programme (normal - 6 kg and delicate - 2.5 kg):**

In both of these programmes you can select three drying levels and three drying times.

6. **Washing and drying programme (cotton - 9 kg - washing and 6 kg - Drying):**

In both of these programmes you can select three drying levels and three drying times.

USING THE APPLIANCE

I. Start/Pause button. Starting the programme

- You can start the programme you have selected by touching the Start/Pause button
- When you turn your machine on, the programme you have selected will be active on the screen. The screens below are an example of what is displayed on screen during washing operations.

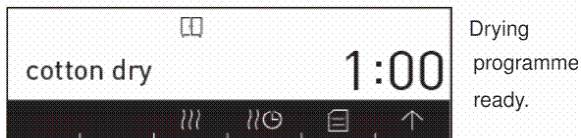
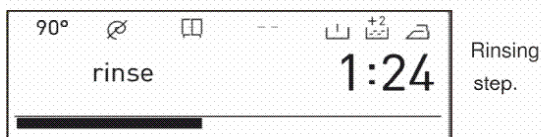
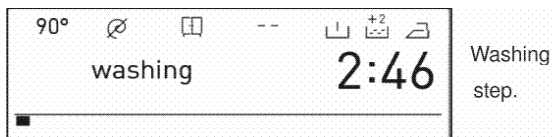
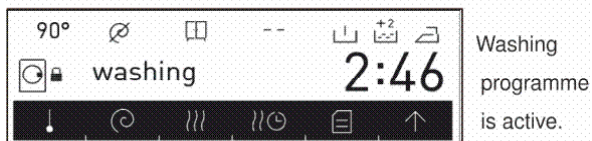
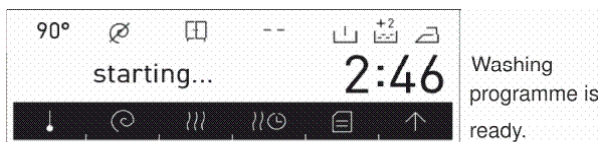

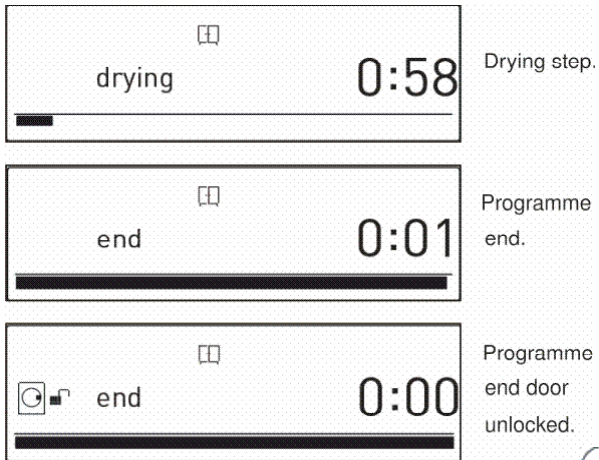

USING THE APPLIANCE

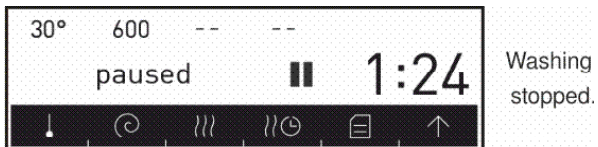

- You can pause or restart the programme you have selected with the  button. You can use this function when you want to add laundry to your machine.



- If  symbol is displayed on the screen, you can open the door of your machine and add laundry.
- If  symbol is displayed on the screen your machine has passed the laundry adding step.

II. Cancelling a programme

If you want to cancel a programme that is running:

- Switch the programme button to the the CANCEL position.
- Your machine will stop the washing operation and the programme will be cancelled.
- To get rid of the water accumulated in the machine switch the programme button to any programme.
- Your machine will perform the necessary discharge operation and cancel the programme.
- You can run your machine by selecting a new programme.

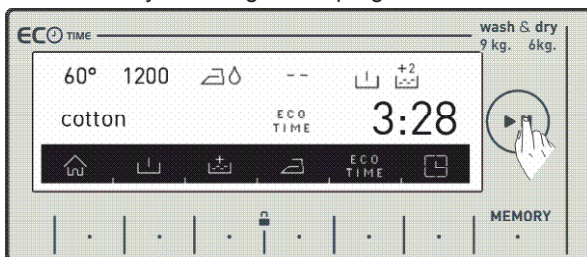

USING THE APPLIANCE

III. Finishing a programme

Your machine will stop by itself as soon as the programme you have selected finishes.

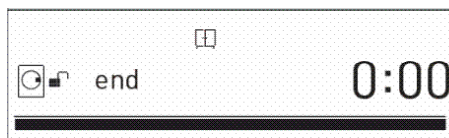



- "end" is displayed on the screen.

- You can open the machine's door and remove the laundry.
- Leave the door of your machine open after removing the laundry so that the machine can dry out.
- Switch the programme button to the CANCEL position.
- Unplug your machine.
- Turn the water faucet off.

If you are not satisfied with the drying level of your laundry, select the best drying programme for your laundry and dry your laundry again.

Note: Your machine has a cooling stage that cools down your laundry at the end of the drying operation.

IV. Child Lock

Your machine has a child lock so that the programme flow is not affected if the function buttons are pressed or the programme knob is turned while the machine is washing or drying. Child lock engages after both of the  buttons next to the  symbol are pressed for more than 3 seconds. The following warning text will be displayed after the child lock engages.

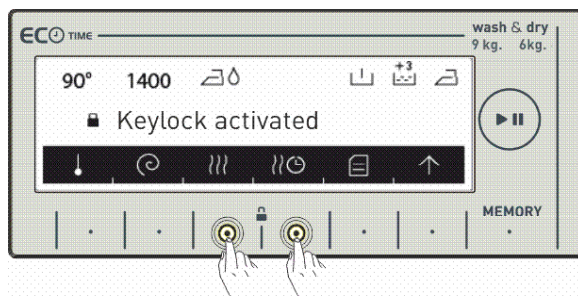

The following text will be displayed if any buttons are pressed while the child lock is engaged.

USING THE APPLIANCE

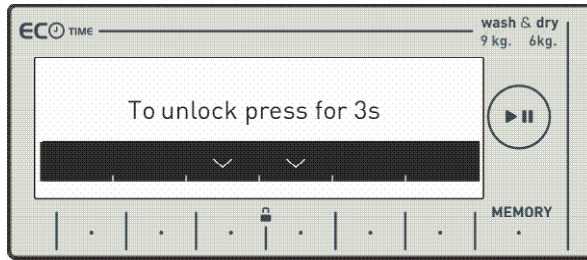

If the child lock is engaged while any programme is running and the programme knob is switched to the CANCEL position and another programme is selected, the programme previously selected continues from where it left. No change will occur. To disengage the child lock, you need to press the  buttons for more than 3 seconds. The following warning text will be displayed after the child lock disengages.

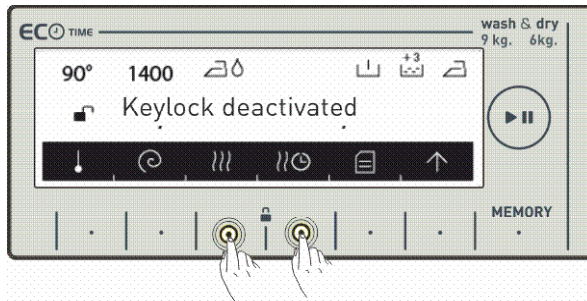

Note: Child lock cannot lock the pump cover or the detergent drawer of your machine.

TABLE OF PROGRAMMES

Washing and drying programmes	Drying Programmes	Wash programmes													
		Programme name	Max. tempo. [°C]	Max. spin speed [rpm]	Max. load [kg]	Additional options	Detergent drawer			Time (h:min)	Number of rinses	Type of laundry			
					Washing	Drying	Additional options	Prewash	Main wash	Fabric softener					
		Cotton	90°	1400	9.0	6.0	1.2, 3	X	●	○	3:05	3	Heavily soiled clothing, or an item that requires bleaching.		
		Cotton Eco*	60°	1400	9.0	6.0	1.2, 3	X	●	○	3:25	2	Lightly soiled cotton or linen clothes.		
		Eco 20	20°	1400	4.0	4.0	1.2, 3	X	●	○	1:45	2	Lightly soiled, sweaty cotton and linen clothes. Wash at 20°C		
		Synthetics	60°	800	3.5	3.5	1.2, 3	X	●	○	2:02	2	Very dirty clothes, clothing made from synthetic fabrics or natural-synthetic fabric blends (nylon, shirts, blouses)		
		Delicates	40°	600	2.5	-	-	X	●	○	0:55	3	NOTE: Do not machine wash woolen fabrics if the coin bag prohibits. The programme is designed for washing outwears.		
		Delux	40°	800	2.5	-	-	X	●	○	1:55	2	The programme is designed for washing outwears.		
		Express	40°	600	3.5	-	1.2, 3	X	X	○	0:43	3	The programme is for ironing with additives (such as amide-starch or softening additives). Reduce the spin speed when washing very delicate fabrics.		
		Always Safe	60°	800	4.5	4.5	1.2, 3	X	●	○	3:00	4	The program is designed for washing clothes of people with sensitive skin, e.g. for children.		
		Memory	-	1400	9.0	-	1.2, 3	X	X	X	0:20	-	Spin-drying after hand washing.		
		Super Rapid 15'	30°	800	2.0	2.0	12,3	X	●	○	0:15	1	Lightly soiled, sweaty cotton clothes and towels.		
		Day 60 90'	60°	1400	4.0	4.0	12,3	X	●	○	1:00	1	Dry cotton coloured laundry.		
		Gentle drying	-	-	-	3.5	1-1100 2-240 3-240	-	-	-	-	-	The programme is designed for drying delicate fabrics.		
		Cotton drying**	-	-	-	6.0	1-1100 2-236 3-340	-	-	-	-	-	The programme is designed for drying cotton laundry.		
		Cotton washing and drying	30°	800	0.5	1.5	1	X	●	○	0:33	1	The programme is designed for quick washing and drying of small amount of laundry weighing up to 0.5 kg (e.g. 3 shirts).		
		Cotton wash and dry	60°	1400	6.0	-	1.2, 3	X	●	○	4:45	3	The programme designed for washing and drying cotton laundry.		

○ Use detergent or fabric softener if necessary.

● Detergent required, without which washing will be ineffective

x Do not use detergent or fabric softener.

* - standard programmes for washing cotton fabrics at 60 °C.

This programme is suitable for washing normally soiled cotton fabrics. This is the most effective programme for washing these type of fabrics, taking into account the total energy and water consumption.

Note: Real water temperature may differ from the declared wash cycle temperature.

** - standard programmes for drying cotton fabrics.

NOTE: Time given is an estimate only. It can differ from the actual washing time depending on temperature, water pressure and quantity of laundry loaded. The time is automatically updated during the wash cycle and it is normal for it to stop or skip.

SELECTING SUB-PROGRAMMES

Synthetics

When you select the Synthetics programme from the programme knob, you will see two sub-program options.

1-Synthetics

2-Curtain

- You can make sub-programme selections by touching the symbol [<] [>] buttons.

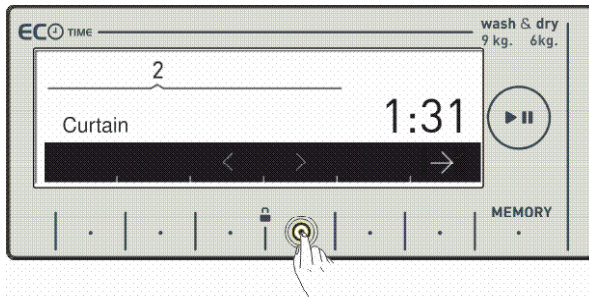
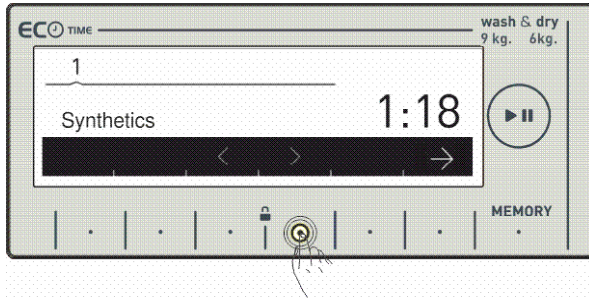

- You can activate the programme you want to select by touching the  symbol button.

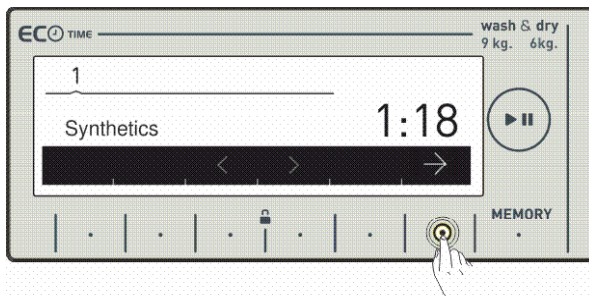

SELECTING SUB-PROGRAMMES

- After the the selection has been activated, the electronic display will return to the main screen of the programme you have selected automatically. You can select other features you want to select on this screen and run the machine by pressing the Start/Pause button.

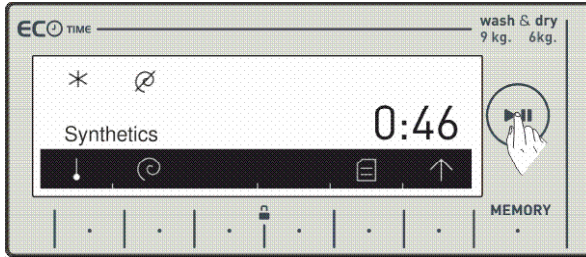

Delicates

When you select the delicates programme from the programme knob, you will see two sub-program options.

- 1- Wool
- 2-Silk

- You can make sub-programme selections by touching the symbol [<] [>] buttons.

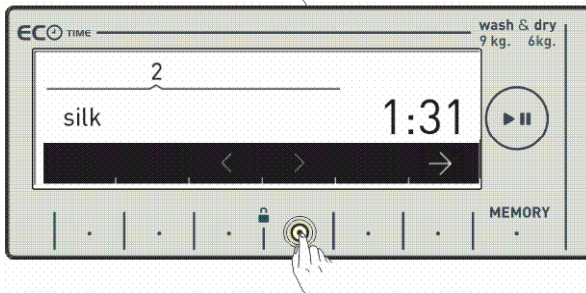
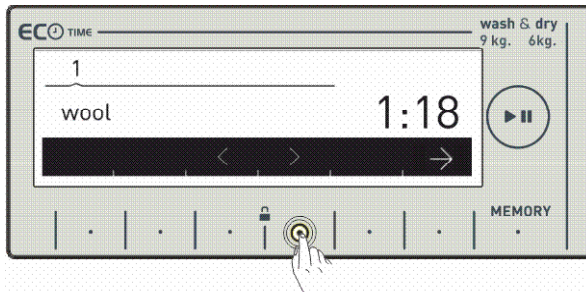

SELECTING SUB-PROGRAMMES

- You can activate the programme you want to select by touching the  symbol button.

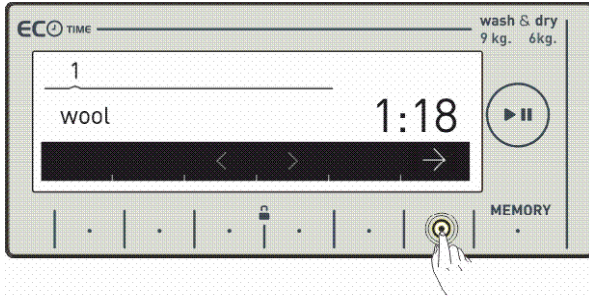

- After the the selection has been activated, the electronic display will return to the main screen of the programme you have selected automatically. You can select other features you want to select on this screen and run the machine by pressing the Start/Pause button.

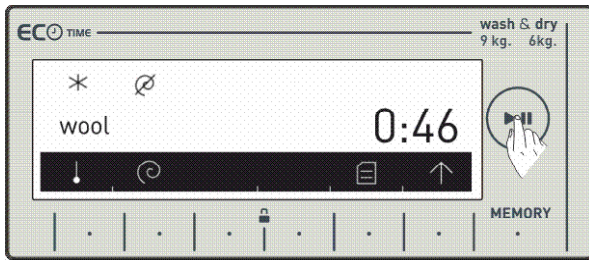

Extras

When you select the extras programme from the programme knob, you will see 6 sub-program options.

- 1- Refresh
- 2- Rinse
- 3- Spin
- 4- Drain
- 5- Drum clean
- 6- Synthetics Wash & Dry

- You can make the sub-programme selections by touching the [<] [>] symbol buttons.

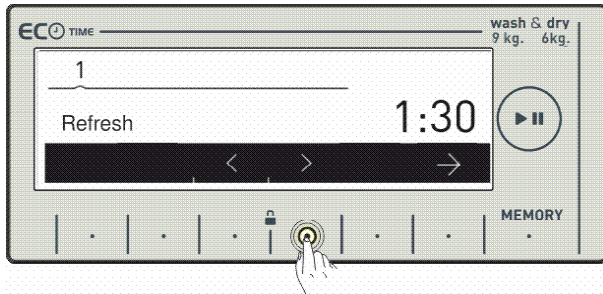

SELECTING SUB-PROGRAMMES

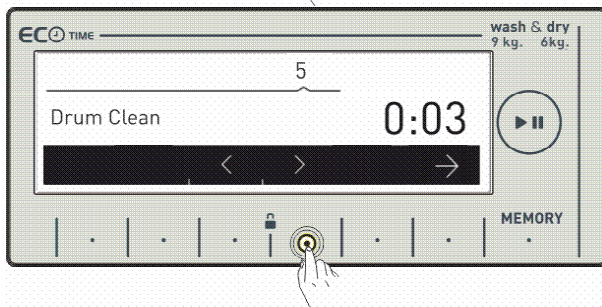
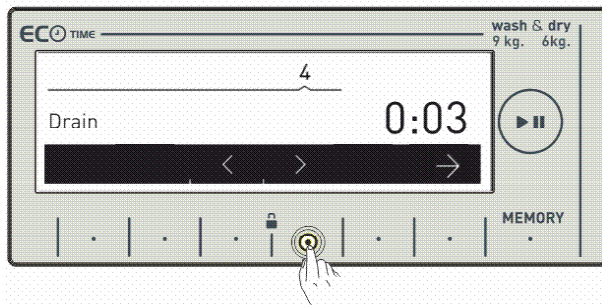
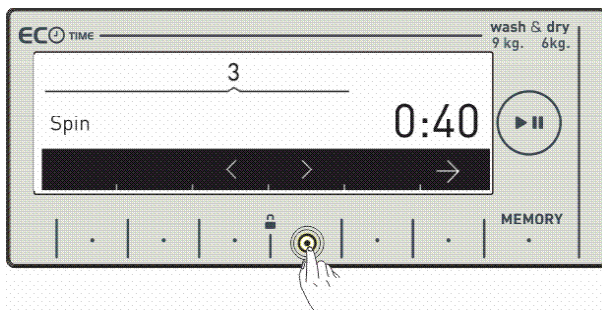
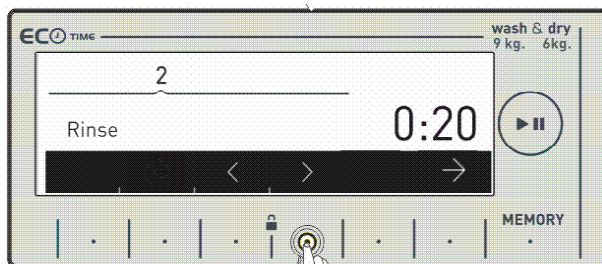

SELECTING SUB-PROGRAMMES

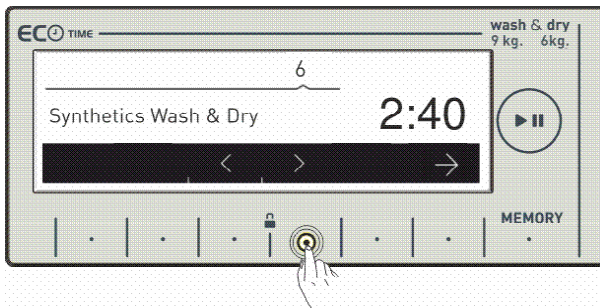
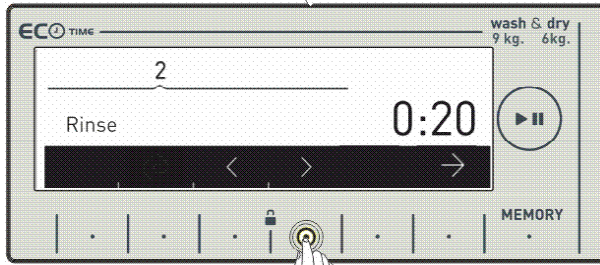

- You can activate the programme you want to select by touching the symbol button.
- After the the selection has been activated, the electronic display will return to the main screen of the programme you have selected automatically. You can select other features you want to select on this screen and run the machine by pressing the Start/Pause button.





TROUBLESHOOTING

Problem	Probable cause/Solution
The appliance does not work	<ul style="list-style-type: none"> - Turn the tap on - Clean the mesh filter on the supply hose - Close the door - Press the [Start/ Pause] button
Water leaks	Properly connect the water intake.
The load in the appliance has not been spun	- Replace the load evenly in the drum, clean the pump filter.
Unpleasant smell in the drum	- Run a hot wash cycle with detergent and no load
No water in the drum	- Turn on the water supply tap.
There is water left in the fabric softener container.	- Firmly press the button in the middle compartment
Washing not properly rinsed	<ul style="list-style-type: none"> - Add correct amount of detergent., depending on how dirty the washing is and the hardness of the water (see the instructions on the detergent's packaging). - Clean the pump filter
The appliance does not fill with water	<ul style="list-style-type: none"> - Turn on the water valve - Check the programme setting - Check the water pressure - Reconnect the water supply hose. - Close the door - Check the water intake is not bent or blocked
Simultaneous intake and draining of water.	- Check that the end of the drain hose is higher than the level of the water in the appliance (the hose should be at a height of 0.6m-1m)
Water does not drain properly	<ul style="list-style-type: none"> - Check the pump filter - Check the drain hose - Check the height of the drain hose, which should be 0.6-1 m from the bottom of the appliance.
Appliance vibrating	<ul style="list-style-type: none"> - Check the transport safety devices have been removed - Level the appliance - Secure the legs (tighten the nuts)
Foam from the detergent drawer.	<ul style="list-style-type: none"> - Reduce the amount of detergent used - Check the water hardness and amount of detergent used, as well as the type of detergent used in the drum
The operation of the appliance is interrupted before the programme has finished	- Check power supply, water supply and water outlet
Noise caused by operation of the outlet pump after water is removed	- The water has been removed from the drum, but small amounts remain in the pump and outlet lead Constant operation of the outlet pump causes air to be sucked in leading to the characteristic noise, which does not mean that anything is wrong
Short breaks during the wash cycle	<ul style="list-style-type: none"> - The water in the appliance is being automatically refilled - Pause caused by removal of excess foam
The laundry is not dried or poorly dried	<ul style="list-style-type: none"> - too big a load — reduce the load in accordance with the table - wait for about 15 minutes and resume drying

TROUBLESHOOTING

The fault indicator lights

The washing machine indicates error codes to help locate minor operating faults and identify their cause. The ERROR CODES help locate and determine the cause. Detected errors are indicated as shown in the following table:

Display indication	Reason	Solution
	Washer-dryer door is opened	Close the washer-dryer door and make sure that laundry is not jammed in the door.
	Low pressure, no water in the drum	Unscrew the water valve, check the water inlet hose and filter, check the water pressure
	Water does not drain properly	Check water drain pump and filter
	Too much water in the washer-dryer	Try to restart or contact the SERVICE CENTRE.

Amica

 Service Help Line

For the UK: please call
0844 815 8880 (non-geographic number)
or **01563 557158** (standard rate call)

For Ireland: please call
0818 46 46 46 (non-geographic number)
or **01 842 8222** (standard rate call)

MAINTENANCE AND CLEANING

Never clean the product's casing or plastic parts using solvents or strong, abrasive detergents (e.g. washing powders or creams)! Use mild liquid detergents and soft cloths only. Do not use sponges.

I. Clean the pump filter

This machine contains a filter system that prevents threads left over from your laundry and other small materials from entering the pump during the discharge operation after a completed wash cycle. This is to protect and prolong the life of the pump. It is recommended that you clean your pump filter once every 2 months.

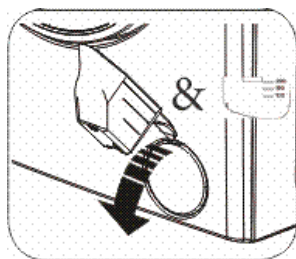

- You may use the washing powder spade supplied with your machine or liquid detergent level plate to open the pump cover.

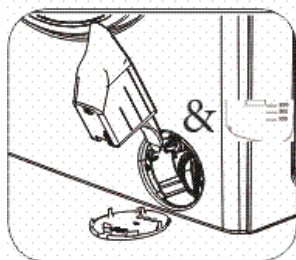

- Lodge the end part of the plastic part to the opening of the cover and press backwards. The cover will be opened.

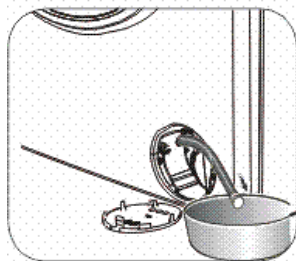

- Pull the black rubber hose and detach it from its clamp, place a container under it and remove its plug.

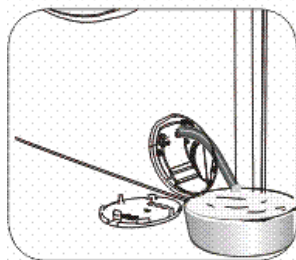

- Collect the discharged water in the container.

MAINTENANCE AND CLEANING

Note: According to the amount of water inside the machine, you may have to empty the water collection container a few times.

- Put back the plug of the black rubber hose after discharging the water.
- Mount the black rubber hose back to its clamp.

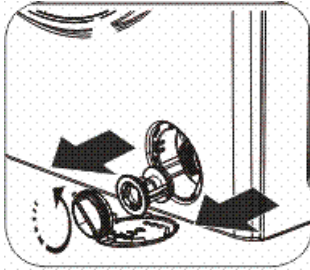

- Loosen the filter cover by turning it counter-clockwise, and remove by pulling.

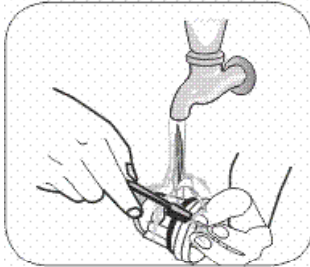

- Clean the foreign materials inside the filter with the help of a brush.

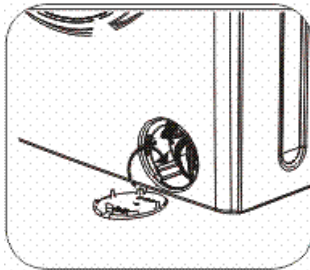

- After cleaning the filter replace the filter cover and tighten by turning clockwise.
- Please note that filter cover will leak water unless properly placed back.

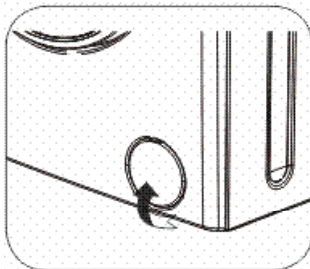

- You can close the pump cover reverse of how you opened it.
- While closing the pump cover, ensure that the parts inside the cover meet the holes on the front panel side.

MAINTENANCE AND CLEANING

II. Cleaning the water supply valve

Filters are in place to prevent foreign substances entering the machine and can be found both on the faucet side of the inlet hose and on the ends of water valves along the water inlet hose of your machine. If your machine cannot intake a sufficient amount of water despite the water faucet being open, these filters should be cleaned.

- Disconnect the ends of the water inlet hose from the tap and the machine.

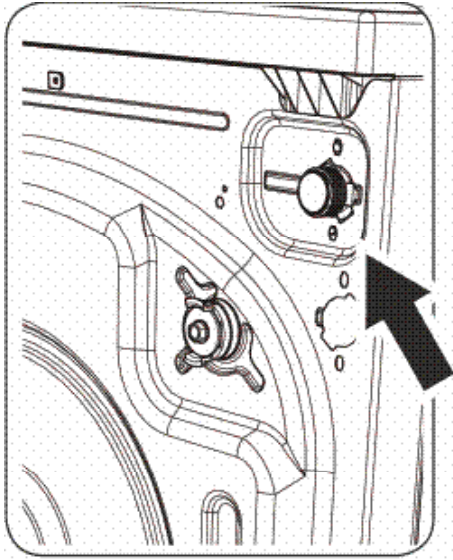

- Remove the filter of the water inlet valve on your machine with a pair of pliers. Clean thoroughly using water and a brush.

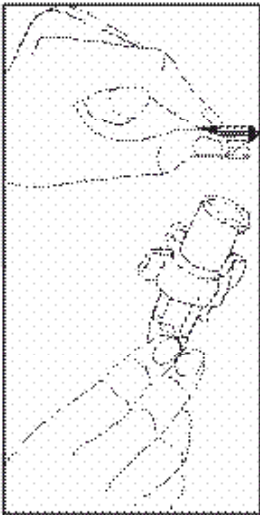

- Disassemble the filter on the faucet side of the water inlet hose manually and clean it.
- Once the filters are cleaned, put them correctly back in place.

MAINTENANCE AND CLEANING

III. Cleaning the detergent drawer (at least once a month).

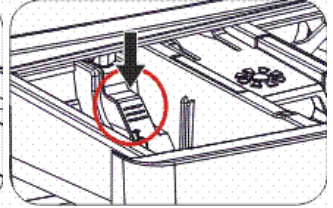
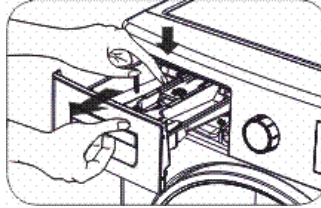
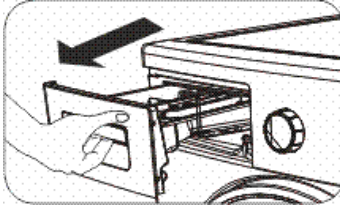

- Your detergents may form residue in the detergent drawer and detergent drawer slot. Remove the detergent drawer in regular intervals to clean the formed residue. In order to remove the detergent drawer from its place:
 - * Pull the detergent drawing all the way back.

- Press the region shown below inside the detergent drawer you have pulled all the way back, and continue pulling and remove the detergent drawer from its place.

- Rinse with a brush and lots of water.
- Collect the residues inside the detergent drawer slot so that they don't fall inside your machine.
- Dry the detergent drawer with a towel or dry cloth and place it back.

- **Do not wash your detergent drawer in a dishwasher.**

For the cleaning and maintenance of the liquid level detergent apparatus, remove the apparatus from its location as shown in the picture below, and thoroughly clean the remaining detergent residues. Replace the apparatus. Make sure that no residual material remains inside the siphon.

PRACTICAL TIPS ON WASHING

I. Detergents and laundry additives

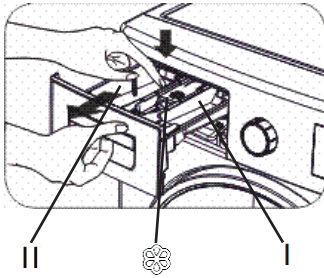

➤ It is recommended to use a general-purpose laundry detergent powder or liquid for the full range of temperatures according to the manufacturer's instructions on the detergent packaging.

Detergents

- Pour the detergent into the drawer compartment marked **II**
- Pour the pre-wash detergent into the drawer compartment marked **I**.

Liquid detergents

- Install the supplied partition in the compartment **III** (figure below).
- Pour liquid detergent into the drawer compartment marked **II**

Fabric softeners added to the rinse

- Pour the fabric softener into the drawer compartment marked 
- Do not exceed the maximum level marked on the drawer compartment. This detergent will be used for the final rinse.

II. First wash

➤ Before washing for the first time, put it through one high temperature cycle without a load, according to the following procedure:

- Connect the appliance to the wall power outlet
- Turn on the water valve
- Set the programme selector knob to high temperature wash.
- Add the appropriate detergent and press the [Start/ Pause] button.

III. Soil

➤ **Stubborn stains**
Before washing garments, apply an additional stain remover according to the instructions for use





Heavy soil:

- One-off washing of smaller amounts of clothes
- Add more detergent
- After washing heavily soiled clothes (e.g. working clothes) or garments which are shedding fibres, it is recommended that the appliance is rinsed out by running a programme cycle at a temperature of 60°C e.g. COTTON, without a load.

Light soil:

- See pt. Conservation.

PRACTICAL TIPS ON WASHING

- IV. Conservation  Reducing energy and water consumption
Garments which are only lightly soiled should be washed on the SUPER RAPID setting.
The appliance detects partial load. For partial load, when using the Cotton programme, the appliance will reduce water and energy consumption and shorten the wash cycle.
- V. Water hardness  Hard water causes scale deposition.
Information about water hardness is available from the nearest water works.
It is advised that water softeners are used for every wash.
- VI. Power failure  (loss of programme settings) Power outage or unplugging the appliance does not cancel the set programme. The programme memory is not volatile and the programme will continue once the power is restored.
Do not open the appliance doors during a power outage.
- VII. Load  **Washing:**
Maximum drum capacity 9 kg:
Load the laundry into the drum according to the following instructions:
- cotton, denim, children's clothes – max full drum (do not force clothes into the drum as this will reduce the quality of the wash!).
 - Synthetics - max 1/2 of the drum.
 - Wool, silk, delicate fabrics - max. approx. 1/3 of the drum.
- CAUTION!** Do not overload the appliance!
Overloading the appliance may damage the clothes being washed!
- The maximum load amounts depending on the programme are given in table of programmes.**
- Drying:**
Maximum drum capacity 6 kg.

PRACTICAL TIPS ON WASHING

VIII. Load distribution control



The electronic control panel contains a balance control system. Before spinning, this checks the distribution of clothes inside the drum.

In the event that too great an imbalance is discovered, it makes several attempts to rearrange the clothes inside the appliance. Sometimes these attempts may be insufficient to properly rearrange the clothes (in the case of towelling dressing gowns washed along with other types of garments, or sheets which have wrapped up in a ball with other items inside).

The system may then react in two ways:

- accept the uneven distribution of garments, but reduce spinning speed,
- decide that the garments are distributed too unevenly and not allow spinning.

In either case, after washing is finished open the appliance door, remove the washing by hand, close the door and select the spin setting again.

IX. Door Lock



The appliance is equipped with a lock which prevents the door from being opened during wash cycle. Once a wash cycle is complete, the door lock is automatically released. In order to open the door during the wash program, press PAUSE button and wait about 2 minutes to unlock the door.

NOTE 1: If there is water in the drum or it is still hot you will not be able to open the door.

NOTE 2: The door cannot be opened during some stages of the wash programme.

X. Delicate fabrics



Programme:

- Select the appropriate wash programme (e.g. DELICATES).

Load

Do not overload the appliance, max 1/3 of the drum, see Load.

XI. Dosing



According to the detergent manufacturer's instructions

Not enough detergent

- The washing turns grey
- Lumps of grease form, scale builds up

Too much detergent



- Strong foaming
- Ineffective washing, detergent incompletely rinsed from fabrics

SPECIFICATION

- Type	AWDI914GJ
- Rated voltage	220-240V / ~50Hz.
- Rated power	2200 W
- Overcurrent protection	10 A
- drum capacity (washing)	max 9 kg
- drum capacity (drying)	max 6 kg
- Water pressure	min 0,1 MPa (1 bar) max 1 MPa (10 bar)
- Dimensions H x W x D	845 / 597 / 582 [mm]
- Net weight	80 kg

Meets the requirements of EU legislation, EN- 50229 standard.

PRODUCT SHEET

The maximum load for washing (dry clothes) (kg)	9.0
The maximum load for drying [kg]	6.0
Spin speed [RPM]	1400
Number of programmes	15
Operating voltage [V]	220-240V
Frequency [Hz]	~50 Hz
Water pressure [MPa]	min 0.1 MPa (1 bar), max 1 MPa (10 bar)
Dimensions (HxWxL) [mm]	845x597x582
Energy consumption (washing, spinning, drying) (kWh/cycle)	6,12 kWh/cykl
Energy consumption (washing and spinning only) (kWh/cycle)	0,9 kWh/cykl
Water consumption (washing, spinning, drying) (litres/cycle)	112 l/cykl
Water consumption (washing and spinning only) (litres/cycle)	48 l/cykl
Control programmes according to: EN 50229	
Wash cycle: "Cotton Eco", load: 9 kg, temperature. 60°C, spin speed: 1400 rpm	
Drying cycle: I. Drying programme for the first part of the load Programme: Cotton drying, load:~4,5 kg ((1 sheet +16 pillowcases) Option: Dry: hanger 	
II. Drying programme for the second part of the load Programme: Cotton drying, load:~4,5 kg (2 sheets + 2 pillowcases + all towels) Option: Dry: hanger 	

* **Note:** Do not dry clothes that have not been washed.

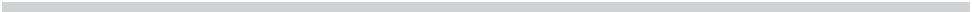
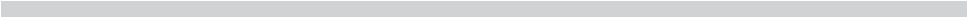

Amica

 Service Help Line

For the UK: please call
0844 815 8880 (non-geographic number)
or **01563 557158** (standard rate call)

For Ireland: please call
0818 46 46 46 (non-geographic number)
or **01 842 8222** (standard rate call)