

Amica

Inteligentny styl

OPERATING INSTRUCTIONS
EN

IO-WMS-0818
(10.2017/1)

WMS714

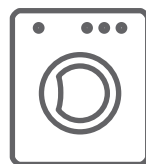

ONLY USE THE APPLIANCE WHEN YOU HAVE READ
AND UNDERSTAND THE OPERATING
INSTRUCTIONS

WASHING MACHINES

CONTENTS

ECOLOGY IN PRACTICE	3
BASIC INFORMATION	5
SAFETY AND GERMEN CARE LABELS	6
INSTALL THE APPLIANCE	17
PRODUCT DESCRIPTION	20
TROUBLESHOOTING	30
PRACTICAL TIPS ON WASHING	35
SPECIFICATIONS	39
PRODUCT FICHE	40



In accordance with European Directive 2012/19/EU and Polish legislation regarding used electrical and electronic goods, this appliance is marked with the symbol of the crossed-out waste container.

This marking indicates that the appliance must not be disposed of together with other household waste after it has been used. The user is obliged to hand it over to waste collection centre collecting used electrical and electronic goods. The collectors, including local collection points, shops and local authority departments provide recycling schemes. Proper handling of used electrical and electronic goods helps avoid environmental and health hazards resulting from the presence of dangerous components and the inappropriate storage and processing of such goods.

ECOLOGY IN PRACTICE

For many years, Amica has consistently pursued pro-ecological policy.

Concern for the environment is as important for us as the use of modern technology. That's why we focus on energy-efficient appliances of the highest energy efficiency class — A+, A++ and A+++.

The development of technology has enabled our factories to become more environmentally friendly – we use less and less water, electricity and less waste water and solid waste is generated in the production.

A lot of attention is paid to materials used in production. We strive to use only those that do not contain harmful substances and make recycling and safe disposal possible after use.



Dear customer!

Thank you for choosing an Amica product. For years we have delivered high-quality appliances, so that household chores become a real pleasure. Before being packaged and leaving the manufacturer, the appliance was thoroughly checked with regard to safety and functionality. We also endeavour to make sure that modern technology in Amica products always goes hand in hand with a unique design.

Before using the appliance, please carefully read these Operating Instructions. Follow these instructions to avoid improper use and ensure long and reliable operation of the appliance. Learn the principles of the safe use to avoid accidents.

Store these operating instructions in a safe place to use them for reference whenever needed. These Operating Instructions contain all the necessary information that will make the use of your Amica appliance simple and fun. We also encourage you to find out more about other Amica appliances.

We hope using your new appliance is a pleasure.

Amica

BASIC INFORMATION



This washing machine is intended for domestic use only to wash textiles and clothes designed to be machine washed in a detergent bath.

Before plugging the washing machine into the mains, remove the safety packaging and ensure the machine is level. The manufacturer reserves the right to introduce changes, which do not affect operation of the appliance.

USAGE

- Carefully read the instructions below before using the appliance.
- Never use the appliance outdoors or anywhere the temperature may fall below freezing.
- The machine should not be operated by children or anyone who has not read the instructions.



Temperatures below 0°C can damage the washing machine! In the event of the machine being stored or transported in sub-zero temperatures, it should be left to acclimatise in a temperature above 0°C for 8 hours before being used.

MANUFACTURER'S DECLARATION

The manufacturer hereby declares that this product meets the requirements of the following European directives:

- Low Voltage Directive, 2014/35/EU,
- Electromagnetic Compatibility (EMC) Directive 2014/30/EE,
- Eco-design Directive 2009/125/EU,
- RoHS Directive 2011/65/EU,

and has been marked with the CE symbol and issued with a declaration of compliance made available to market regulators.

The risk of death!	<p>This appliance should not be used by children under 8 years of age, persons with reduced physical or mental capabilities, and persons who do not have sufficient skills to use this type of appliance. Such persons should be offered proper supervision or instructions on safe handling of appliance and related risks. Children must not play with the appliance or perform any maintenance-related activities. Children under 3 years of age must be kept away from the appliance unless continuously supervised.</p>
	<p>Children could get caught inside the appliance and get into a life-threatening situation.</p>
Risk of suffocation!	<p>If you allow children to play with the packaging/film or parts of the package, they can get entangled or put packaging over their head and risk suffocation. Keep packaging/plastic film or parts of packaging out of reach of children.</p>
Risk of poisoning!	<p>Washing detergents and fabric softeners can cause poisoning if ingested. In the event of accidental ingestion, consult your doctor. Washing detergents and fabric softeners should be stored out of the reach of children.</p>

<p>Risk of burns!</p>	<p>If laundry is washed at high temperature, door glass becomes hot. Prevent children from touching the hot door.</p>
<p>Eye/skin irritation!</p>	<p>Contact with detergents and softeners may cause eye or skin irritation. In case of eye/skin contact, thoroughly rinse eyes/skin to remove fabric detergent/softener. Washing detergents and fabric softeners should be stored out of the reach of children.</p>
<p>Risk of electric shock. Risk of fire/damage to property/appliance!</p>	<p>If the appliance is not correctly installed, it may be dangerous. Make sure that:</p> <ul style="list-style-type: none">Mains voltage corresponds to the voltage indicated on the appliance nameplate (identification plate)The current load and required fuse protection are specified on the nameplate. <p>The appliance is connected to AC source only through a properly installed and grounded wall socket in accordance with national standards.</p>

<p>Risk of electric shock. Risk of fire/damage to property/appliance!</p>	<p>The power cord and the grounded wall socket fit together and the grounding system has been properly installed.</p>
	<p>Power cord cross section is sufficient.</p>
	<p>Power plug is always accessible.</p>
	<p>If a miniature circuit-breaker is used, always use a circuit-breaker with the following designation:  This symbol is the only way to make sure that all the necessary requirements have been met.</p>
<p>Risk of electric shock. Risk of fire/damage to property/appliance!</p>	<p>If the power cord is modified or damaged, it may result in electric shock, short circuit or fire due to overheating.</p> <p>The power cord must not be kinked, crushed or modified or come in contact with any heat source.</p>

Risk of fire/damage to property/appliance!	The use of extension cords or splitters may result in fire due to overheating or short circuit. Connect the appliance directly to a properly grounded wall socket. Do not use extension cords, splitters or power strips.
Health risk / risk of damage to property/appliance!	The appliance may vibrate or displace while in use, potentially causing injury or property damage. Set the appliance on a clean, level and hard surface using a level spirit.
	If any protruding items are caught by the appliance (e.g. doors) when trying to lift or move it, the item may come off and cause injury. Do not grasp any protruding parts of the appliance to move it.
Risk of injury!	The appliance is very heavy. Lifting may cause injury. Do not lift this appliance by yourself.

<p>Risk of injury!</p>	<p>This appliance has sharp edges that can cause a hand injury. Do not hold the appliance by sharp edges. Only lift the appliance after you put on the gloves.</p>
<p>Important! Damage to property/appliance</p>	<p>If the hoses or electrical cables are not routed properly, you can trip and sustain an injury. Rout hoses and cables so that they do not constitute a tripping hazard.</p>
	<p>If the water level is too high or too low, the appliance may not work properly, which can cause damage to property/appliance. Make sure that water is supplied under pressure of minimum 100 kPa (1 bar) and not exceeding 1000 kPa (10 bar).</p>
	<p>If the water supplying hoses have been modified or damaged, this can cause damage to property/appliance. The water supply hoses must not be kinked, crushed, modified or cut.</p>
	<p>The use of third-party hoses to connect the appliance to water supply can cause damage to property or the appliance.</p>

<p>Important! Damage to property/appliance</p>	<p>Use only hoses supplied with the appliance, or the original hoses up designed for the appliance.</p> <p>The appliance is secured for transport with transit bolts. If you don't remove transit bolts before using the appliance, the appliance may be damaged. Remove all transit bolts before using the appliance for the first time.</p> <p>Make sure you keep transit bolts in a safe place for future use. If the appliance will be transported, to avoid any damage, you must reinstall the transit bolts.</p>
<p>Risk of explosion/fire hazard!</p>	<p>Laundry washed with detergents that contain solvents and thinners pose a risk of explosion in the drum.</p> <p>Thoroughly rinse laundry with water before washing in the washing machine.</p>

Risk of poisoning!	<p>Cleaning agents containing solvents may give off poisonous vapours.</p> <p>Do not use cleaning agents containing solvents.</p>
Risk of injury!	<p>Do not lean against/sit on open appliance door as this can lead to the appliance tipping over.</p> <p>Do not lean against the open door of the appliance.</p>
	<p>Climbing on the appliance may cause the worktop to break or collapse and lead to an injury</p> <p>Do not climb on the appliance.</p>
	<p>Reaching into the drum while it is still rotating could injure your hand.</p> <p>Wait until the drum has come to a standstill.</p>
Risk of scalding!	<p>When washing at high temperature, there is a risk of scalding as a result of contact with hot water and detergent (e.g. when you drain the water into the sink).</p> <p>Do not put your hands in hot water with detergent solution.</p>

<p>Eye/skin irritation!</p>	<p>Fabric detergents and softeners may splash, if the detergent drawer remains open during operation. In case of eye/skin contact, thoroughly rinse eyes/skin to remove fabric detergent/softener. In the event of accidental ingestion, consult your doctor.</p>
<p>Important! Damage to property/appliance</p>	<p>If the amount of laundry in the washing machine exceeds the maximum load, it may not operate properly or cause damage to property or the appliance. Do not exceed the maximum load capacity of dry laundry. Do not exceed the maximum load capacity for individual wash programmes.</p> <p>Adding too much detergent or fabric softener may cause damage to property or the appliance. Use fabric detergent/softener according to the manufacturer's instructions.</p>

The risk of death!!	The appliance is powered by electricity. Touching live elements poses a risk of electric shock. Therefore, remember:
	Turn off the appliance: Unplug the appliance from the wall outlet.
	We never grab the plug with wet hands.
	When pulling the plug, always hold the plug, not the power cord, because this can damage the power cord.
	Do not make any technical modifications to the appliance or its components.
	Any repairs or other work on the appliance must only be performed by our service facility or by an electrician. The same applies to replacing the power cord (if necessary).
	You can order a spare power cord in our service centres.

<p>Risk of poisoning!</p>	<p>Cleaning agents containing solvents may give off poisonous vapours.</p> <p>Do not use cleaning agents containing solvents.</p>
<p>Risk of electric shock / damage to property / appliance!</p>	<p>If water penetrates into the appliance, it may cause a short circuit. Never use pressure washer or steam cleaner to clean the appliance.</p>
<p>Health risk / risk of damage to property/appliance!</p>	<p>The use of third-party spare parts and accessories is dangerous and may cause injury, damage to property or appliance. For safety reasons, use original spare parts only.</p>
<p>Important! Damage to property/appliance</p>	<p>Fabric cleaners, impregnating agents, stain removers, pre-wash agents, etc. may damage the appliance outer surface.</p> <p>Therefore, remember:</p>

<p>Important! Damage to property/appliance</p>	<p>Make sure there is no contact with the appliance surface.</p>
	<p>Clean the appliance with a damp cloth only.</p>

UNDERSTANDING THE SYMBOLS ON CLOTHES LABELS

Washing				
	boil at 90°C	normal wash at 60°C	normal wash at 40°C	Do NOT wash!
	delicate		handwash	
Chemical cleaning				
	all solvents	all except TRI	petrol only	NO Dry clean!
Tumble dryer				
	normal	low	high	Do NOT dry!
Ironing				
	110°C	150°C	200°C	Do NOT Iron



Always pay attention to the symbols on garment labels when choosing a washing programme.

INSTALL THE APPLIANCE

1

Remove the transit bolts
(keep the bolts for future use, e.g. when moving house).

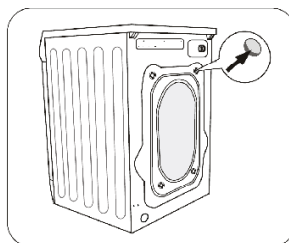
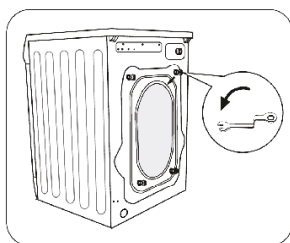

- unscrew the 4 transit bolts with a spanner,
- remove the rubber and plastic transport brackets from the sockets along with the washers and bolts.
- stop up the holes with the stoppers enclosed in the accessories bag.



Caution: the transit bolts **MUST** be removed before the washing machine is used!

2

Position and level the washing machine

- place the washing machine on a solid, level surface,
- loosen the plastic washer (2)
- Level the appliance by adjusting the legs (1)
- lock with washers (2)

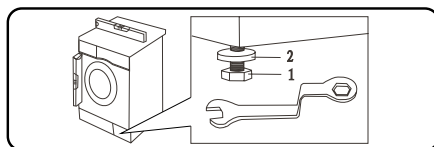
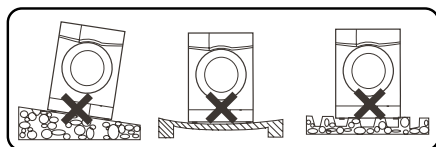

After positioning and levelling the appliance, check that it is stable by pressing down each corner and ensuring it does not move!

3

Connect the water supply

- Use only the new hoses supplied with the machine. Do not re-use hoses.

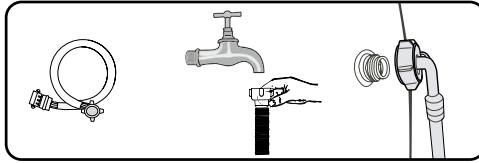

- A supply hose with seals is inside the drum of the machine.
Water pressure min 0.05 MPa (0.5 bar), max 1 MPa (10 bar).

- 1). after connecting, make sure the hose is not twisted
- 2) after connecting the hose and the valve, check they are sealed tight
- 3). regularly check the condition of the hose.



Supply the machine with cold water only.

4

Water drain

- The drain hose is at the back of the machine. Fix the drain hose so that it does not move while the washing machine is in operation. If necessary, use the elbow (1).

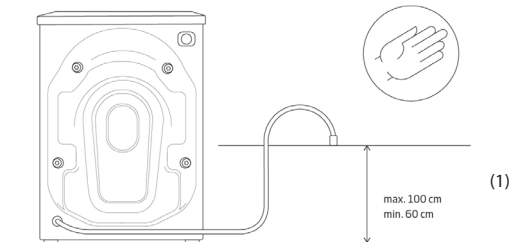

Connection on the left

Connection on the right

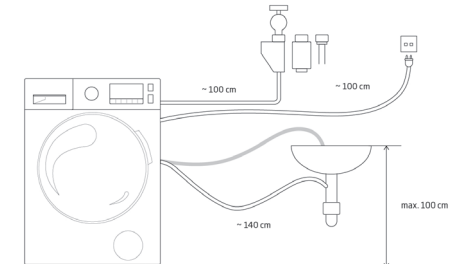
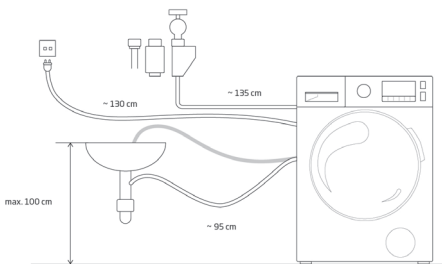

5

Connect to power supply

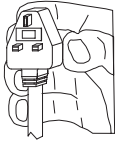
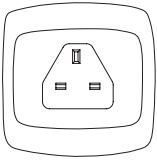

- Electrical wall outlet where the appliance is connects must be in a visible and accessible place,
- Only plug the appliance into a properly installed socket with an earthing pin,
- Do not use an extension cord to connect the appliance,
- in the event of the power cord being damaged, it must be replaced by an authorised service technician,
- the electrical system to which the appliance is to be connected must be protected with a 10 A fuse.

Prepare to wash:

- Small items such as coins, paper clips, needles, etc., may damage the laundry and the washing machine, you should therefore follow a few important recommendations:
 - 1). Empty pockets
 - 2). Remove all metal items
 - 3.) Delicate items such as bras or stockings should be washed in protective mesh laundry bag
 - 4). Close zippers and fasten buttons

FEATURES AND COMPONENTS

DESCRIPTION OF THE APPLIANCE



Compartment A
use with liquid detergent.

Compartment II
detergent for the main wash, water softener, bleach, stain remover.

Compartment 
Fabric softener, liquid starch — do not exceed the max level

Compartment I
Pre-wash detergent

1. Detergent drawer
2. Drum
3. Control Panel
4. Door handle
5. Pump filter cover

DISPLAY AND CONTROL PANEL

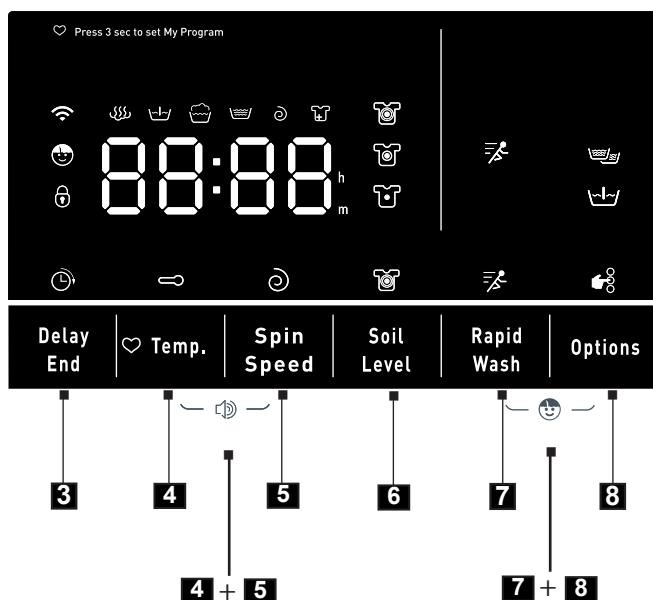
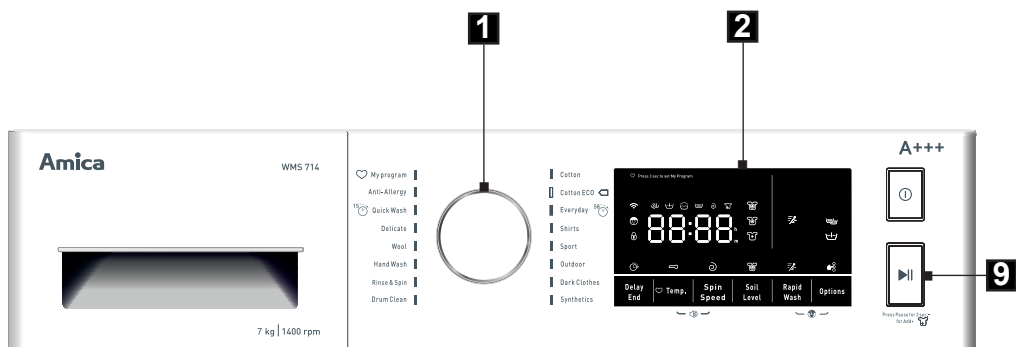

1. Programme selector dial
2. Display
3. **Time Remaining**
4. **Temperature**
5. **Spin**
6. **Soil Level**
7. **Rapid Wash**
8. **Options**
9. **Start/Pause**
- 4+5 Acoustic Signal On/Off**
- 7+8 Child Lock**















1

Programme selector dial

- Choose the appropriate wash programme as required, depending on the soil level, and type and amount of laundry loaded, which ensures better results and more effective washing. Once the wash programme is started, turning the programme selector knob to another position is indicated by a beep, however it does not change the previously selected programme.

2

Display

- Large and easy to read display provides instant access to information about each programme. During appliance operation the display shows the approximate remaining wash time and  (flashes when you can still pause the programme and add laundry). The display also shows these symbols: door locked , Child Lock , Wi-Fi (*) , steam  (*), Opti-dose  spin, programme symbols    @, soil level    and options (extra rinse  / pre-wash ) , rapid wash . The displayed time is an estimate and may differ from actual wash cycle time, depending on temperature, water pressure, load size, quantity of washing powder used etc. The time is automatically updated during wash cycle. Displaying the same time for an extended period or abrupt changes are normal.

Washing machines with LCD display also show the maximum load for the programme selected with programme selector knob.

For a programme with full load the FUL message is displayed for 5 seconds. Then programme time is displayed. For a programme with half a load the HLF message is displayed for 5 seconds. Then programme time is displayed. For other programmes the maximum load weight [kg] is displayed for 5 seconds. Then programme time is displayed.

3

Time Remaining button

- When you select Time Remaining, the display will show time remaining until the end of the programme . With this option the user selects the time remaining until the end of the programme and the washing machine will fit the entire wash cycle in this time entered by the user.

Press the button to set the time remaining until wash cycle must end.

4

Temperature selector button

- This button allows the washing temperature to be set in different programmes. Press this button to display water temperature settings available for a given programme or an option for washing in cold water (no heating). Depending on the selected programme, the display will show the following settings: - - °C (cold water), 20°C, 30°C, 40°C, 60°C, 90°C.

* Available on selected models

5

Spin speed selector button

- Press this button to set the spin speed when water is being pumped out of the washing machine. Press  To change the settings. Depending on the programme selected, the display shows the following values: 0 (no spinning), 600, 800, 1000, 1200, 1400, 1600*

Three soil levels

6

- This feature allows you to wash laundry in accordance with your needs — quickly and efficiently, in a standard or intensive wash cycle. For any selected programme (see table) you can select one of three levels of soil: slightly soiled, heavily soiled and very heavily soiled. This allows you to:

- 1). Make clean, ecological and economic wash.
- 2). Select washing options depending on your current needs.



Level 1 — for lightly soiled laundry. Normally this option is turned off. With each level wash programmes become more intensive. Main wash is extended by 2-10 minutes to make it more effective.



Level 2 — standard wash cycle, whose algorithm cannot be modified, designed for moderately soiled garments.



Level 3 —designed for heavily soiled laundry. The same amount of water is drawn as in level 2, but the duration of the wash cycle is extended by about 10 minutes.

The list below shows programmes where soil level can be selected:

Programmes	Select the type of stains	Programmes	Select the type of stains
Cotton	Option	Autoclean	-
Cotton Eco	-	Rinse	-
Daily 58'	-	Hand wash	Option
Shirts	Option	Wool	Option
Physical fitness	Option	Delicate	Option
Out-of-home advertising	Option	Express 15'	-
Dark	Option	Antiallergic	-
Synthetics	Option	Favourites	

* maximum speed depends on your model.

7

Rapid Wash

- This option reduces the time by $\frac{1}{3}$ in relation to the original programme duration. Water consumption is unchanged. The function is recommended when washing lightly soiled laundry.



The Rapid Wash function is not available for all programmes. (see Table of wash programmes.)

8

Extra Rinse

- The function is especially useful when washing underwear and also clothes for people with sensitive skin. Select this option to add an extra rinse to wash cycle.

Pre-wash

- The Pre-wash function extends the wash cycle by approximately 20 minutes. The laundry is prewashed before the main wash cycle begins. Use the Pre-wash to achieve excellent washing results without the need to soak the laundry. Pre-wash is recommended when washing heavily soiled laundry. Pre-wash is carried out at a temperature of 30°C.



The Pre-wash function is not available for all programmes. (see Table of wash programmes.)



Pour suitable detergent to detergent drawer marked with the  symbol before the Pre-wash function is activated.

OPTI DOSE

* OptiDose — automatic (liquid) detergent dispensing



AUTO

- Washing machine with automatic detergent dispensing is more eco-friendly, economical and easy to use. The washing machine automatically adds the correct amount of liquid detergent for the selected programme and the amount and type of laundry.
- Use OptiDose button to adjust the liquid detergent dispensing.
- Press and hold the OptiDose button for 3 seconds to turn off the OptiDose option. Press and hold the OptiDose button for 3 seconds again to turn on the OptiDose  option.
- The OptiDose button is used for automated dispensing of liquid detergent. You can choose the detergent dose — small, medium, large — or turn off the system.
- A small dose of 22.5 ml of liquid detergent is recommended 1-3 kg load.
- The medium dose of 30 ml of liquid detergent is recommended for 3-5 kg load.
- A large dose of 37.5 ml of liquid detergent is for 6-9 kg load.
- The capacity of rinse aid tank is 0,6 l and for detergent tank it is 1 l.
- The dose of rinse aid dispensed is 22.5 ml each time.



Flashing droplet  indicates low level of one of the liquids.



Detergent must be dispensed according to the manufacturer's recommendations.



At the maximum dose of the detergent, capacity of the tank is enough for about 20 wash cycles.



* Laundry ball

A user intending to use washing powder must disable OptiDose (automated liquid detergent dispensing), and then put the laundry ball with washing powder inside the washing machine and start the wash cycle.

* Steam Touch 

■ Steam Touch:

- 1.) increases the efficiency of difficult stain removal,
- 2.) conditions laundry for ironing — it is less wrinkled,
- 3.) removes harmful bacteria and dust mites – this is a great option for people with sensitive skin and allergies,
- 4.) tackles the causes of odour — not only neutralizes but removes them.

■ Steam is generated during the wash cycle — it penetrates the fibres while straightening, cleaning and loosening them. Steam disinfects the fabric, kills germs and tackles even the toughest stains, while not destroying the laundry.

■ Steam helps remove stubborn stains, and laundry becomes even softer. The use of steam is safe and does not compromise the washed laundry.



If you select this option, steam is applied twice during a programme — during the last rinse and spinning. Rinse cycle is extended by 7 min, energy consumption by 0.1 kWh and water by 0.7 l. Spin cycle is extended by 5 min, energy consumption by 0,07kWh and water consumption by 0.5 l.

* Available on selected models

9

Start/Pause button

- Press Start/Pause to start or pause a programme. During the washing cycle the corresponding programme phase symbol is flashing. In Pause mode, the symbols do not flash and are lit up continuously. The Pause mode can be used to soak the laundry.
- Under the Start/Pause button there is the  Add+ option button (allowing you to add laundry during the programme, such as pants, shirts or socks). Washing machine clearly indicates when you can add more laundry.



The Add+ option is the perfect solution for all those who are forgetful! You can open the door during the wash cycle, so that you add or remove laundry even a long time after the programme has started. The LED indicator on the Control Panel indicates pausing a programme is possible. When can stop the programme and add the laundry, the display flashes the icon  Add+. If the temperature is below 60°C and the water level below the door seal, you can stop the programme by pressing the Start/Pause and then instantly unlock door to add laundry. The available options will be communicated through quick flashing of the relevant indicator (until programme progresses to 70-80%). Although this option is available for almost the entire duration of the programme it is recommended that you use it in the first 30 minutes to maximize the results.

4+5

Acoustic Signal On/Off

- The Acoustic Signal On/Off is activated by simultaneously pressing and holding: Temperature selector and Spin Speed buttons for about 3 seconds.

7+8

Child Lock

- This function locks function buttons to prevent settings being changed or operation interrupted by children. Press and hold Rapid Wash and Options buttons for 3 seconds to activate the Child Lock during a washing cycle. To release Child Lock during the cycle, hold the same buttons down once more for around 3 seconds.



When If the Child Lock function is activated, the display will show the  symbol. When you turn off or unplug the washing machine or the washing cycle ends, the Child Lock function will not deactivate.



Select a favourite programme.

- To set the Favourite programme turn the knob on any programme and set temperature, spin speed and additional functions. Then, press and hold down the Temperature button for about 3 seconds to confirm the Favourite programme setting. When saved, the setting will be now always available under Favourites. You can change the Favourite programme as many times as you want. The default is the Cotton programme.

1

Antiallergic

- This programme is designed for washing clothes of children and people with sensitive skin or skin allergy. Virtually all allergens, dust mites, bacteria, microbes or fungi are removed from the washed clothes. It also removes stubborn stains. It will not damage clothing and is suitable for washing delicate laundry such as children's garments. Main wash temperature is 30°C (possible temp. settings: --° C (cold water), 20°C, 30°C, 40°C), and then there are 4 rinse cycles in heated water.

2

Autoclean

- The drum auto cleaning helps maintain high hygiene — this is especially important for people with allergies, and for washing children's clothes. Programme results:
 - 1). Eliminates most allergens (bacteria, fungi, mould and microorganisms), accumulating in the drum.
 - 2). This programme is used with empty drum. Do not wash any laundry with this programme. For this programme use washing machine cleaning products from reputable manufacturers.
 - 3). Thank to this programme laundry is free from odours, most commonly caused by micro-organisms that collect in the washing machine drum.

The programme takes about an hour and it sterilises the drum at 90-95°C.

3

Daily 58'

- Quick, full washing programme that takes 58 minutes.
 - 1). Offers the full and effective wash cycle in less than an hour.
 - 2). Helps you save time and offers the convenience of using the washing machine.

4

Express 15'

- Use this programme to refresh clothes. Includes all three wash stages:
 - 1). Main wash
 - 2). Rinse
 - 3). Spinning

USING THE APPLIANCE

1

Select Programme

- Set the programme selector turning it left or right.
- Customize the programme to your needs – you can change the temperature, spin speed, or enable additional features.
- Press the Start/ Pause button

2

Time Remaining

To set the Time Remaining:

- Close the appliance door.
- Set the programme selector dial to the desired programme (see table).
- Select additional functions or wash cycle parameters as required – depending on the needs,
- Press the Time Remaining button.
- Select time remaining ranging from 1 to 24 hours.
Press the Start/ Pause button The appliance will be set in delay mode.
- The wash programme will be automatically terminated.



When you set the Time Remaining option, the display will show the time remaining to the end of the programme.

3

End of the wash cycle

- End of the wash cycle is indicated by acoustic signal (if active). 30 seconds after the end of the wash programme, END appears on the display, washing machine turns off automatically, the display turns off, the door is unlocked and the washing machine will be in off mode).
- Close the water valve.
- Unplug the appliance from the mains.
- Open the door and remove laundry.

4

Cancel or modify programme

- Press and hold the Pause button for 3 seconds to reset a programme.

TROUBLESHOOTING

Problem	Probable cause/Solution
The washing machine is not working	<ul style="list-style-type: none"> Open the water supply tap. - clean the mesh filter on the supply hose - close the door - press the Start/ Pause button
Water Leakage	<ul style="list-style-type: none"> - Properly connect the water supply hose.
The load in the appliance has not been spun	<ul style="list-style-type: none"> - Replace the load evenly in the drum, clean the pump filter.
Unpleasant smell in the drum	<ul style="list-style-type: none"> - Run the drum autoclean programme
No water in the drum	<ul style="list-style-type: none"> - Open the water supply tap.
There is water left in the fabric softener container.	<ul style="list-style-type: none"> - Press down on the plastic tab located in the central compartment of the detergent tank.
Washing not properly rinsed	<ul style="list-style-type: none"> - Add correct amount of detergent, depending on the soiling level and water hardness (see the instructions on the detergent packaging).
The appliance does not fill with water	<ul style="list-style-type: none"> - Open the water valve, - check programme settings, - check water pressure, - reconnect the water supply hose. - close the door - check that water intake hose is not bent or blocked
Simultaneous water intake and draining.	<ul style="list-style-type: none"> Check that the end of the drain hose is higher than the level of the water in the appliance (the hose should be at a height of 0–100 cm).
Water does not drain properly	<ul style="list-style-type: none"> - check the pump filter, - check the drain hose, - check the placement of the drain hose — it should be at a height of 0.6 to 1 m from the floor.

Problem	Probable cause/Solution
Appliance vibrating	<ul style="list-style-type: none"> - Check if transit bolts are removed - level the washing machine, - lock the washing machine feet by tightening the nuts.
Foam leaks from the detergent drawer.	<ul style="list-style-type: none"> - Reduce the amount of detergent used - Check the water hardness and the amount of detergent used, - Use detergent according to manufacturer instruction on the box indicated for your water hardness.
The operation of the appliance is interrupted before the programme has finished	<ul style="list-style-type: none"> - Check electric power supply, water supply and water outlet.
Noise caused by operation of the outlet pump after water is removed	<ul style="list-style-type: none"> - There is no reason for concern. The water has been removed from the drum, but small amounts remain in the pump and outlet lead. Constant operation of the outlet pump causes air to be sucked in leading to the characteristic noise, which does not mean that anything is wrong.
Short breaks during the wash cycle	<ul style="list-style-type: none"> - Water in the appliance is being automatically refilled - Pause caused by removal of excess foam

THE FAULT INDICATOR LIGHTS

The washing machine features an alert system that indicates ERROR CODES on the display to help locate minor operating faults and identify their cause. The ERROR CODES help locate and determine the cause.

Detected errors are indicated as shown in the following table:

Display indication	Reason	Explanation
E10	Low pressure, no water in the drum	Open the water valve, check the water inlet hose and filter, check water pressure
E12	Overflow	Restart the appliance
E21	Water does not drain properly	Check water drain pump and filter.
E30	Washing machine door not lock when you close the	Close the washing machine door and make sure that laundry is not jammed in the door.
Others		Try to restart or contact the SERVICE CENTRE.

Amica

 Service Help Line

For the UK: please call
01949 862012

For Ireland: please call
0818 46 46 46 (non-geographic number)
or **01 88 2010** (standard rate call)



While signaling an error washing machine also beeps (if active).

EMERGENCY UNLOCKING

for example, in the event of a power failure

The programme will be continued when power is restored.

To remove the laundry, the door can be opened in the following ways:

Warning!

Danger of scalding!

When washing at high temperature there is a risk of scalding in case of contact with hot detergent solution or hot laundry.

Leave to cool.

Warning!

Risk of injury!

Inserting your hand into a rotating drum can lead to injury.

Do not put your hands into the rotating drum.

Wait until the drum stops completely.



Important!

Damage caused by water.

Leaking water can cause damage.

Do not open the door, if you can see water level through the door glass.

1. Turn off the appliance: Remove the plug from the mains socket.
2. Drain the water from the washing machine.
3. Pull the emergency unlock using the tool and let go.

You can then open the door.

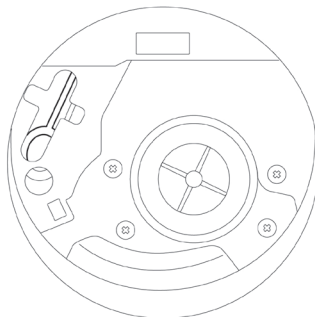



Never clean the appliance body or plastic parts using solvents or harsh, abrasive detergents (e.g. washing powders or creams)! Use mild liquid detergents and soft cloths only. Do not use sponges.

1

Clean the pump filter

- Clean the pump filter every 20 washes or so. Neglecting to clean the filter may result in problems with draining water from the appliance!

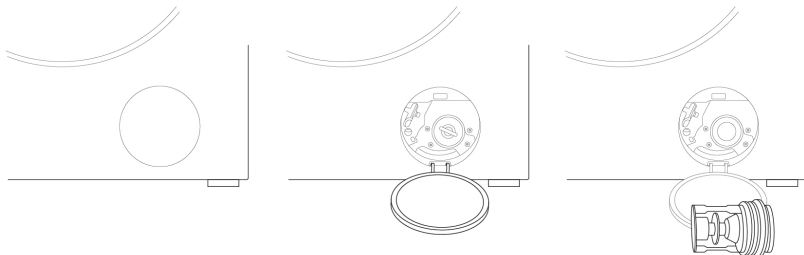

Unplug the appliance from the wall outlet,

- 2). close the water valve,
- 3). open the filter cover using hand or flat screwdriver,
- 4). unscrew filter
- 5). remove and clean the filter.

2

Clean the water supply valve

- Replace the filter following the procedure in reverse order.

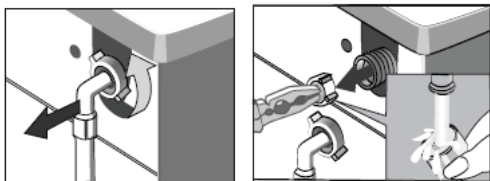

- 1). unscrew on the water supply hose,
- 2). use forceps to grasp the filter mesh pin,
- 3). remove and clean the filter, preferably using a brush.

3

Clean the detergent drawer

- Should be cleaned at least once a month.

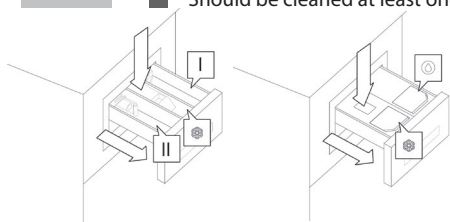

- 1). pull out the detergent drawer.
Press down the tab and completely remove the drawer.
- 2). rinse under running water, clean with a brush or a piece of fabric,
- 3). replace the drawer.

PRACTICAL TIPS ON WASHING

DETERGENTS AND LAUNDRY ADDITIVES



It is recommended to use a general-purpose laundry detergent powder or liquid for the full range of temperatures according to the manufacturer's instructions on the detergent packaging.

1

Detergents

- Pour the detergent into the drawer compartment marked **II**
- Pour the pre-wash detergent into the drawer compartment marked **I**

2

Liquid detergents

- Install the tab supplied in the compartment **II**
- Pour liquid detergent into the drawer compartment marked **II**

3

Fabric softeners added to the rinse

- Pour the fabric softener into the drawer compartment marked 
- Do not exceed the maximum level marked on the drawer compartment. This detergent will be used for the final rinse.

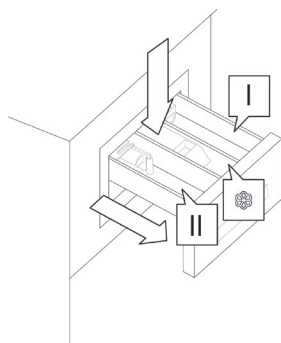

For washing whites it is recommended to use the washing powder. Liquid detergents do not contain bleach. Do not use rinse aid with white laundry, as this may cause yellowing of laundry.

FIRST WASH

- Before washing for the first time, put the appliance through one high temperature cycle without a load, according to the following procedure:

- 1). connect the washing machine to the power supply,
- 2). open the water valve,
- 3). set the programme selector dial to washing at high temperature, add a suitable detergent and press Start/Pause.

SOIL

1

Stubborn stains

- Before washing underwear, apply an additional stain remover according to the instructions for use.

2

Heavy soil

- in order to achieve a better result, wash less laundry,
- add more detergent.
- Rinse the washing machine after washing heavily soiled garments (e.g. work clothes) or clothing that loses fibres. To do this, run the wash cycle at 60°C, for example Cotton or Synthetics without any load.

3

Light soil

- See Conservation.

CONSERVATION

Reduce energy and water consumption

- Garments which are only lightly soiled should be washed on the Rapid Wash setting.
- For most programmes, the washing machine detects load.
For partial load, when using the Cotton programme, the appliance will reduce water and energy consumption and shorten the wash cycle.

WATER HARDNESS

- Hard water causes scale deposition. Information about water hardness is available from the nearest water works. We recommend that you use water softener for each washing.

POWER OUTAGE (PROGRAMME MEMORY)

- Power outage or unplugging the appliance does not cancel the set programme. The programme is memorised and resumes when power is restored. Do not open the appliance doors during a power outage.

LOAD

- Maximum drum capacity 7 kg.
- Load the laundry into the drum according to the following instructions:
 - 1). cotton, denim, children's clothes – max full drum (do not force clothes into the drum as this will reduce the quality of the wash),
 - 2). Synthetics – max ½ of the drum,
 - 3). wool, silk, delicate fabrics – of the drum.



Do not overload the appliance. Overloading the appliance may damage the clothes being washed! If you overload the appliance the OVL is shown appears on the display — remove excess laundry from the drum and restart the washing machine. The maximum load amounts depending on the programme are given in table of programmes.

LOAD DISTRIBUTION CONTROL

- The appliance features load distribution control system. Before spinning, this checks the distribution of clothes inside the drum. In the event that too great an imbalance is detected, the system makes several attempts to rearrange the clothes inside the appliance. Sometimes these attempts to distribute the load are not successful. Problems may be caused by terrycloth robes washed together with other types of laundry, such as bed sheets that formed a bundle around other items of laundry.
- The system may then respond in two ways:
 - 1). accept the uneven distribution of garments and reduce spin speed,
 - 2). cancel the spinning.

In either case, after washing cycle is finished open the appliance door, remove the laundry by hand, close the door and select the spin setting again.

DOOR LOCK

- The washing machine is equipped with a lock which prevents the door from being opened during wash cycle. Once a wash cycle is complete, the door lock is automatically released.



If there is water in the drum or it is still hot you will not be able to open the door. Opening the door is not possible during some wash cycle stages.

DELICATE FABRICS

1

Select Programme

- Select the appropriate wash programme: Synthetics, Wool, Delicates.

2

Load

- Avoid overloading the washing machine — the maximum load is 2.5 kg for delicate fabrics, see "Loading."

ADD DETERGENT

1

Not enough detergent

- the laundry turns grey, lumps of fat form, lime scale is deposited.

2

Too much detergent

- A lot of foam, ineffective washing, detergent incompletely rinsed from fabrics.

SPECIFICATION

Type	WMS714 (WMAD4 7143C1UZD0W)
Rated voltage	220-240V / ~50Hz
Rated power	2050 W
Overcurrent protection	10 A
Drum capacity	max. 7 kg
Water pressure	min. 0.05 MPa (0.5 bar) max. 1 MPa (10 bar)
Dimensions Depth/Height/Breadth	850/595/495 [mm]
Weight	61 kg
Meets the requirements of the following EU regulations	EN-60456 standard.

Testing for label information in accordance with EN 60456 using the standard cotton wash programmes:

- Cotton 60°C at full load
- Cotton 60°C at partial load
- Cotton 40°C at partial load

average annual water consumption is 9900 l/year weighted average electricity consumption is 174 kWh/year

PRODUCT SHEET

(According to the Commission delegated Regulation (EU) No 1061/2010 of 28 September 2010 supplementing Directive of the European Parliament and of the Council 2010/30/EU with regard to energy labelling of household washing machines and Commission Regulation (EU) No 1015/2010 of 10 November 2010 implementing Directive 2009/125/EC of the European Parliament and of the Council with regard to eco-design requirements for household washing machines).

Supplier's name or trade mark	Amica S.A.
Type	WMS714 (WMAD4 7143C1UZD0W)
Drum capacity	7.0 kg
Energy efficiency class ^{1) 2)}	A+++
Annual weighted average energy consumption AE_c ³⁾	174 kWh/year
Energy consumption of the standard cotton programme:	
- at 60°C, full load $W_{t,60}$	0.9 kWh
- at 60°C, partial load $W_{t,60/2}$	0.79 kWh
- at 40°C, partial load $W_{t,40/2}$	0.55 kWh
Power consumption in the off-mode P_o	0.5 W
Power consumption in standby mode P_i	1 W
Annual weighted average water consumption AW_c ⁴⁾	9900 l/year
Energy consumption of the standard cotton programme:	
- at 60°C, full load $W_{t,60}$	50 l
- at 60°C, partial load $W_{t,60/2}$	41 l
- at 40°C, partial load $W_{t,40/2}$	41 l
Spin-drying efficiency class ²⁾	B
Residual moisture content D	53 %
Maximum spin speed attained ²⁾	1400 rpm
Duration of the "standard 60°C cotton programme" at full load	205 min
Duration of the "standard 60°C cotton programme" at partial load	200 min
Duration of the "standard 40°C cotton programme" at partial load	200 min
Noise Level:	
- during the wash cycle	Noise 58 dB (A) re 1 pW
- during the spin cycle	Noise 76 dB (A) re 1 pW
Equipment designed for fitting	no

1) Energy efficiency class on a scale from A+++ (more efficient) to D (less efficient).

2) For a standard Cottons 60°C and 40°C wash programme at full and partial load.

3) Estimated weighted annual energy consumption based on 220 standard wash cycles for Cottons 60°C and 40°C at full and partial load and energy consumption in power saving modes. Actual energy consumption depends on how the appliance is used.

4) Estimated weighted annual water consumption based on 220 standard wash cycles for Cottons 60°C and 40°C at full and partial load. Actual water consumption depends on how the appliance is used. This household washing machine is equipped with a power management system, and, at the end of the programme, it automatically reverts to off-mode. Period of time in standby mode is less than 1 minute.



Amica

 Service Help Line

For the UK: please call
01949 862012

For Ireland: please call
0818 46 46 46 (non-geographic number)
or **01 88 2010** (standard rate call)